

WEATHERTEX CONSTRUCTION DETAIL GUIDE

WEATHERGROOVE PANELS

20mm CAVITY CONSTRUCTION



WEATHERGROOVE PANELS | 20mm CAVITY CONSTRUCTION

These drawings are for information only. They do not contain full details required for construction and must be used in conjunction with the current issue Weathertex Installation Manual, New Zealand Construction Code, E2/AS1 and any other Local Regulations. Weathertex recommends gaining professional advice to ensure the drawings are suitable for your project. Weathertex accepts no liability in respect to the use of these drawings.

PAGE 3

OFF STUD WEATHERGROOVE JOINER DETAIL
ON STUD BUTT JOIN DETAIL

PAGE 4

SMALL Z FLASHING JOIN DETAIL
Z FLASHING JOIN DETAIL
Z FLASHING INTO CORNER DETAIL

PAGE 5

SMALL TRADITIONAL INTERNAL "W" CORNER DETAIL
SMALL TRADITIONAL EXTERNAL "BOX" CORNER DETAIL
SMALL INTERNAL LF CORNER DETAIL
SMALL EXTERNAL LF CORNER DETAIL

PAGE 6

WINDOW JAMB DETAIL
LINTEL DETAIL
WINDOW SILL DETAIL

PAGE 7

METER BOX JAMB DETAIL
METER BOX HEAD DETAIL
METER BOX SILL DETAIL

PAGE 8

DOOR HEADER DETAIL

PAGE 9

CONCRETE SLAB GROUND CLEARANCE DETAIL

PAGE 10

FLUSH WITH BRICK VENEER DETAIL

PAGE 11

PARAPET DETAIL
CANTILEVER ROOF DETAIL

PAGE 12

EAVE AND ROOF CLEARANCE

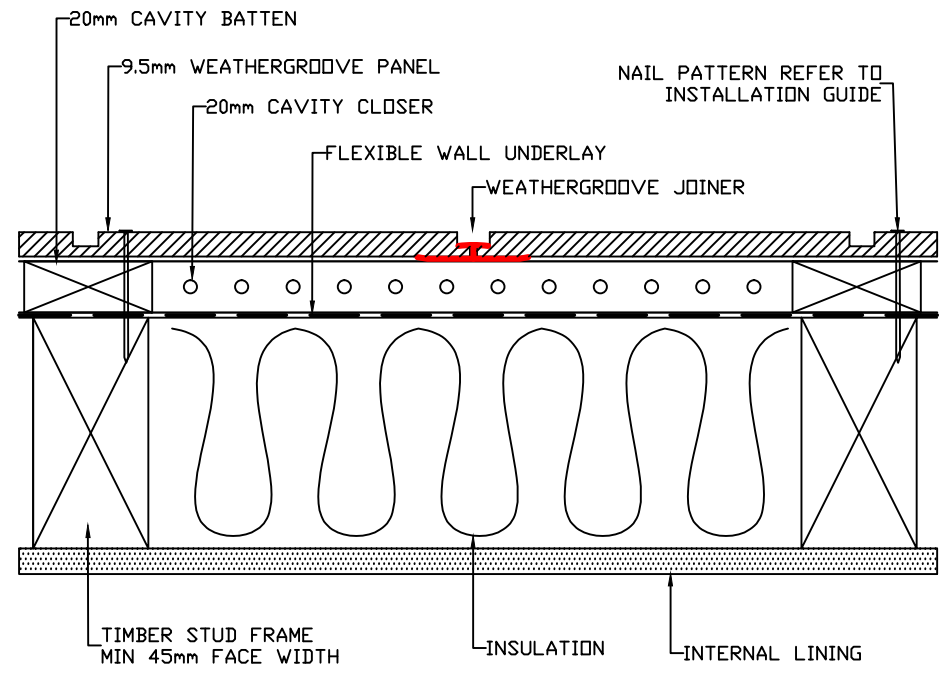

OFF STUD WEATHERGROOVE JOINER DETAIL

A

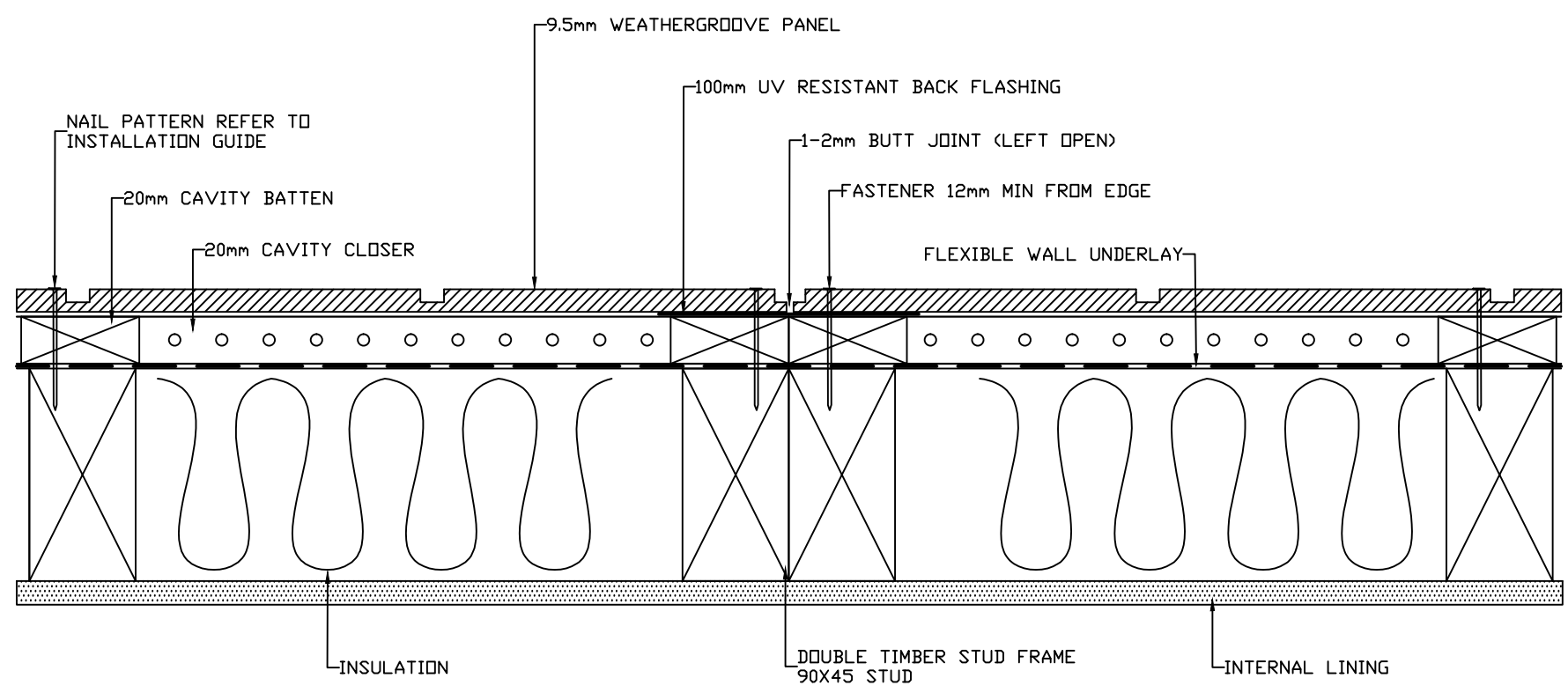

ON STUD BUTT JOIN DETAIL

B

	DRAWING NAME:	SCALE:	DRAWN BY:	CHECKED BY:	DATE:	DRAWING No.:	SHT SIZE
	20mm CAVITY INSTALLATION - WEATHERGROOVE	NTS	A.MOATE	C.O'NEILL	29.04.19	CD-WG-C20-01	A3

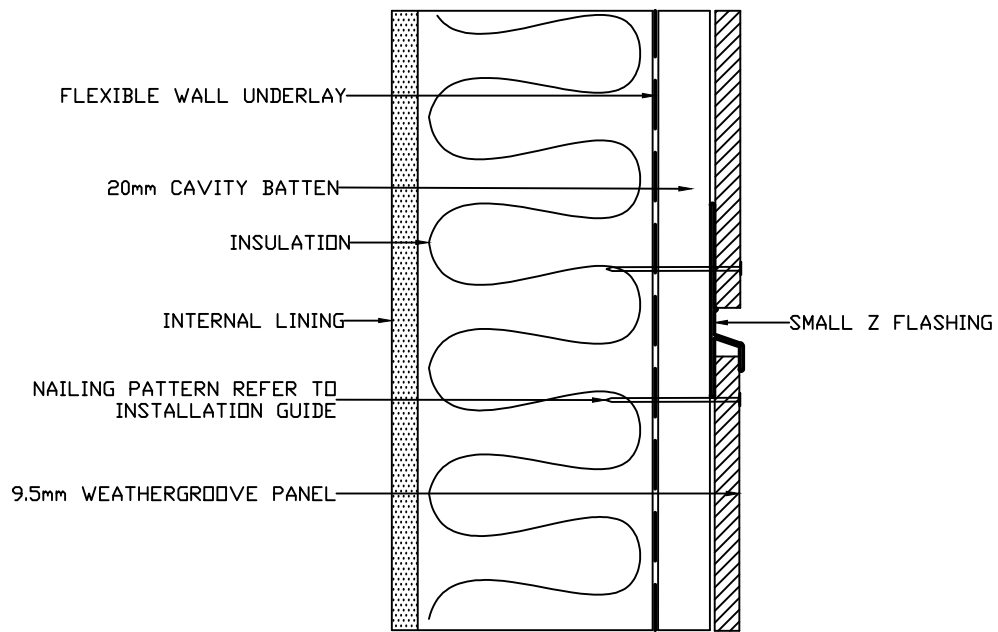

SMALL Z FLASHING JOIN DETAIL

(NOT SUITABLE FOR INTER STOREY JUNCTIONS. SEE E2/AS1)

A

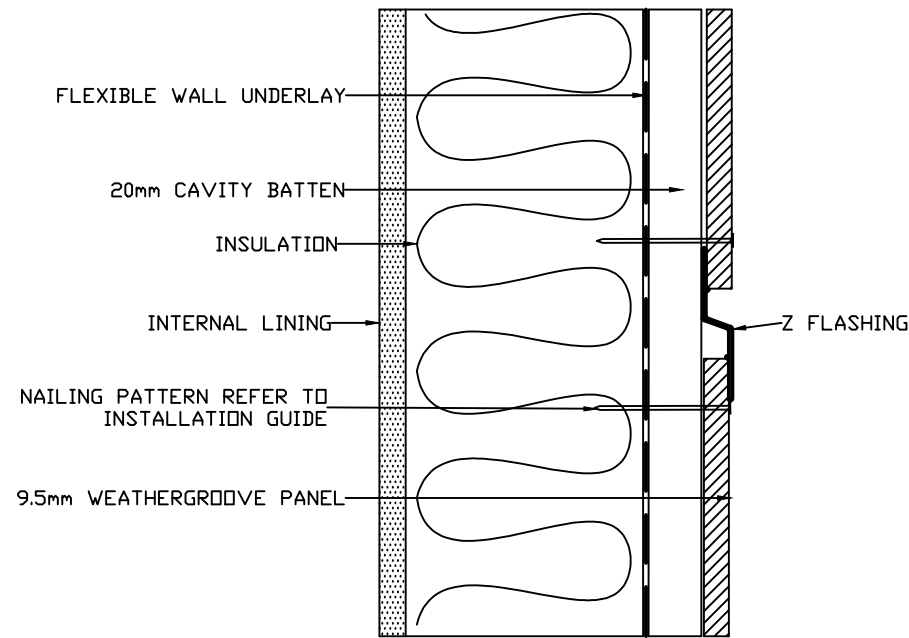

Z FLASHING JOIN DETAIL

(NOT SUITABLE FOR INTER STOREY JUNCTIONS. SEE E2/AS1)

B

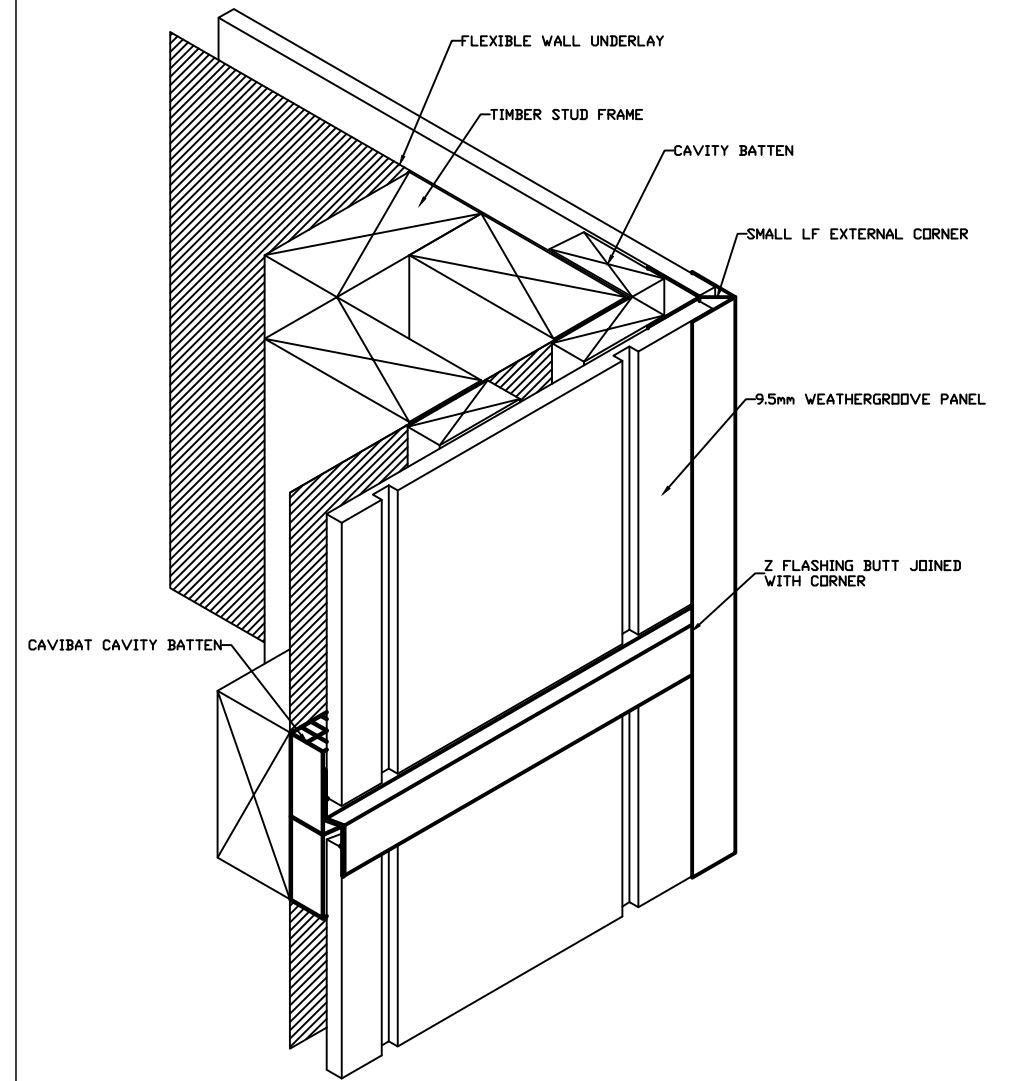

Z FLASHING INTO CORNER DETAIL

C



DRAWING NAME:
20mm CAVITY INSTALLATION - WEATHERGROOVE

SCALE:
NTS

DRAWN BY:
A.MOATE

CHECKED BY:
C.O'NEILL

DATE:
29.04.19

DRAWING No.:
CD-WG-C20-02

SHT SIZE
A3

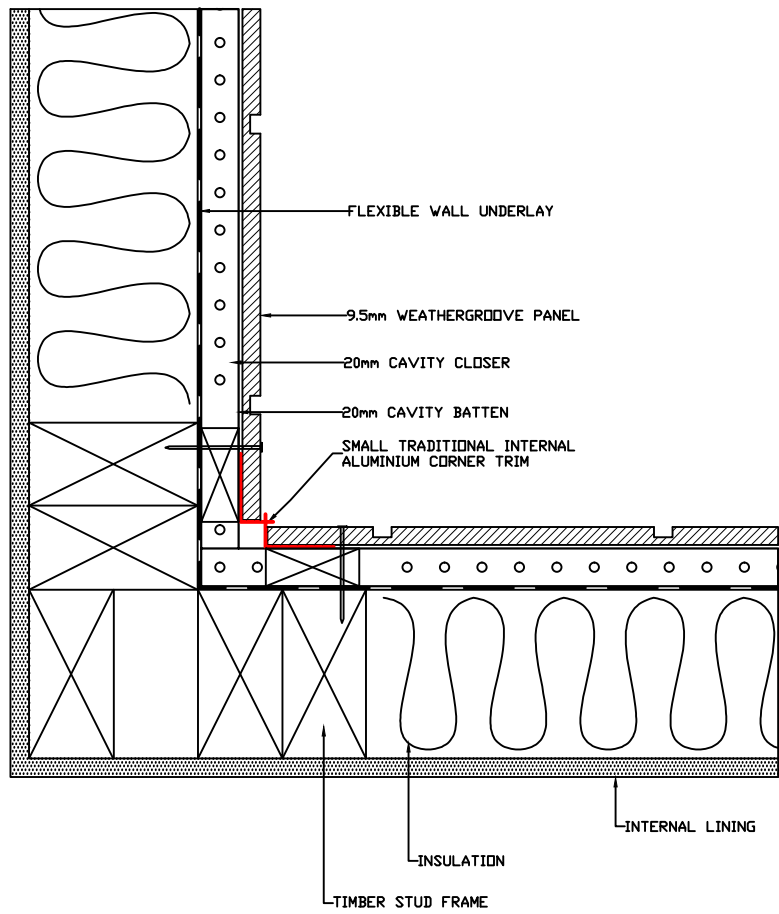

A SMALL TRADITIONAL INTERNAL "W" CORNER DETAIL

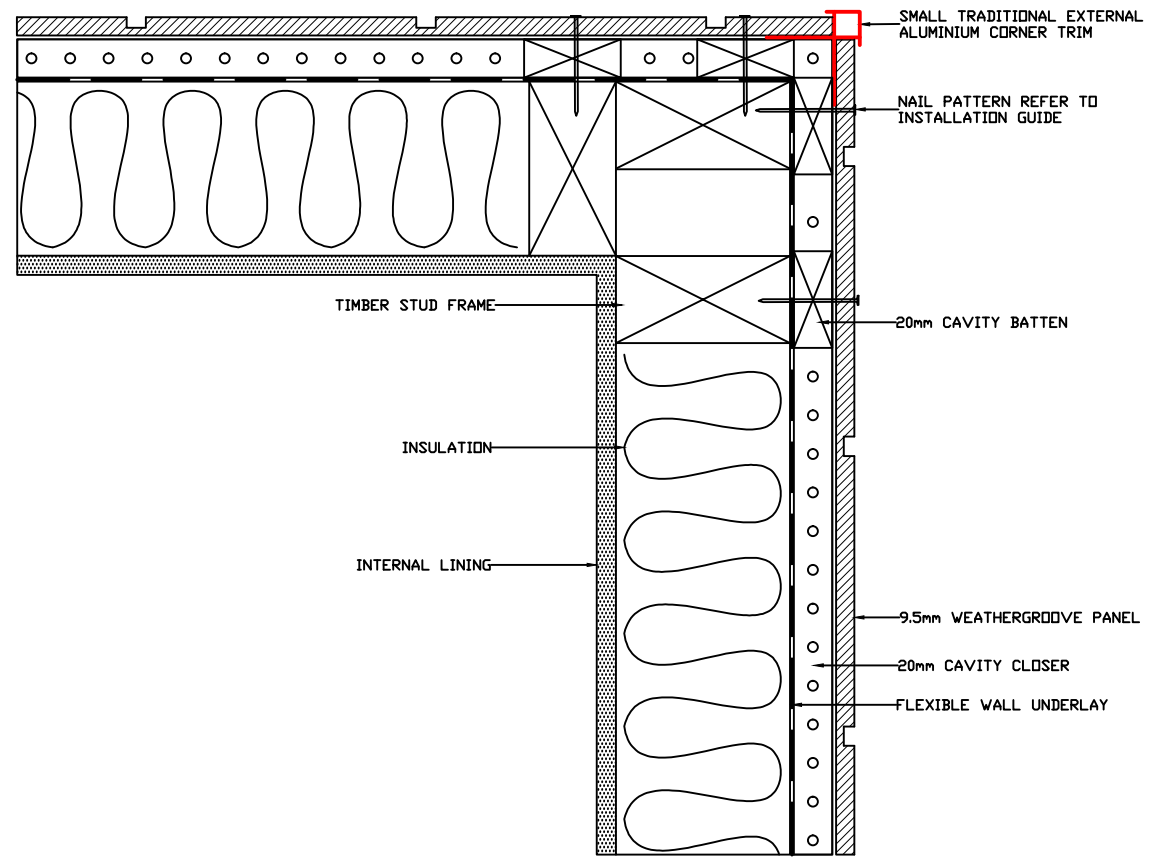

B SMALL TRADITIONAL EXTERNAL "BOX" CORNER DETAIL

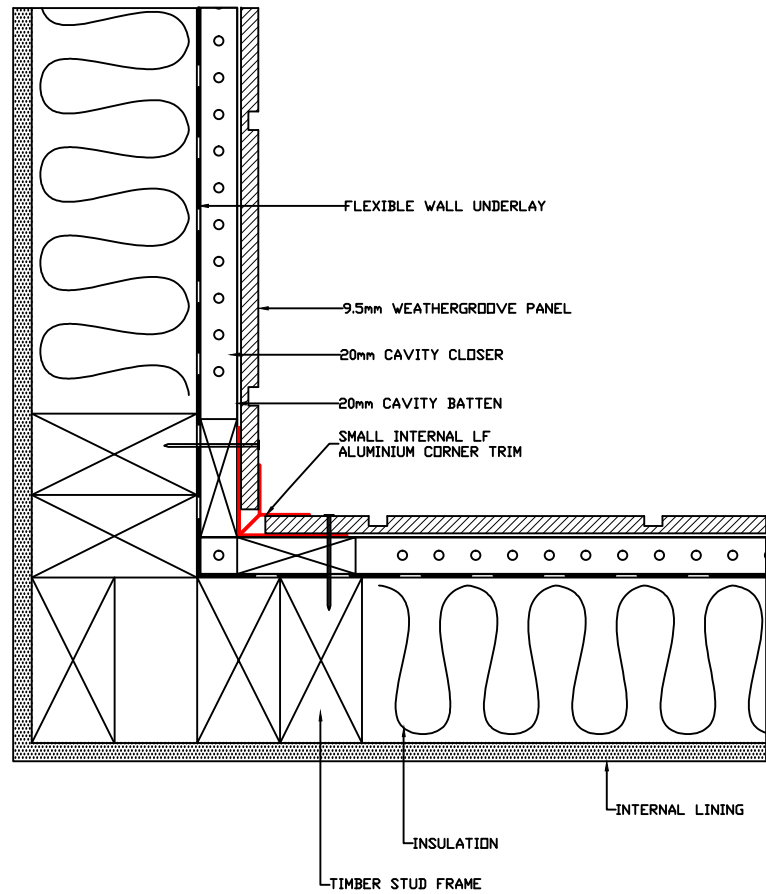

C SMALL INTERNAL LF CORNER DETAIL

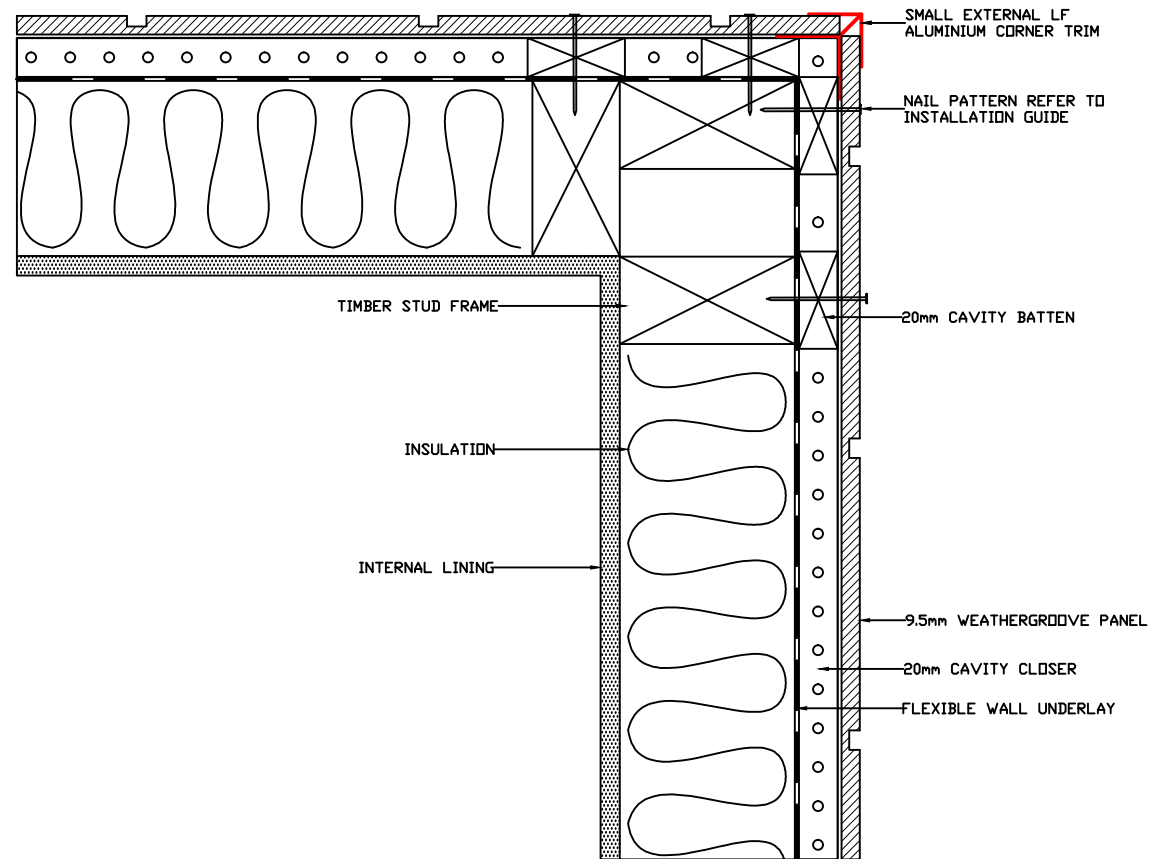

D SMALL EXTERNAL LF CORNER DETAIL

C

D



DRAWING NAME:
20MM CAVITY INSTALLATION - WEATHERGROOVE

SCALE:
NTS

DRAWN BY:
A.MOATE

CHECKED BY:
C.O'NEILL

DATE:
29.04.19

DRAWING No.:
CD-WG-C20-03

SHT SIZE
A3

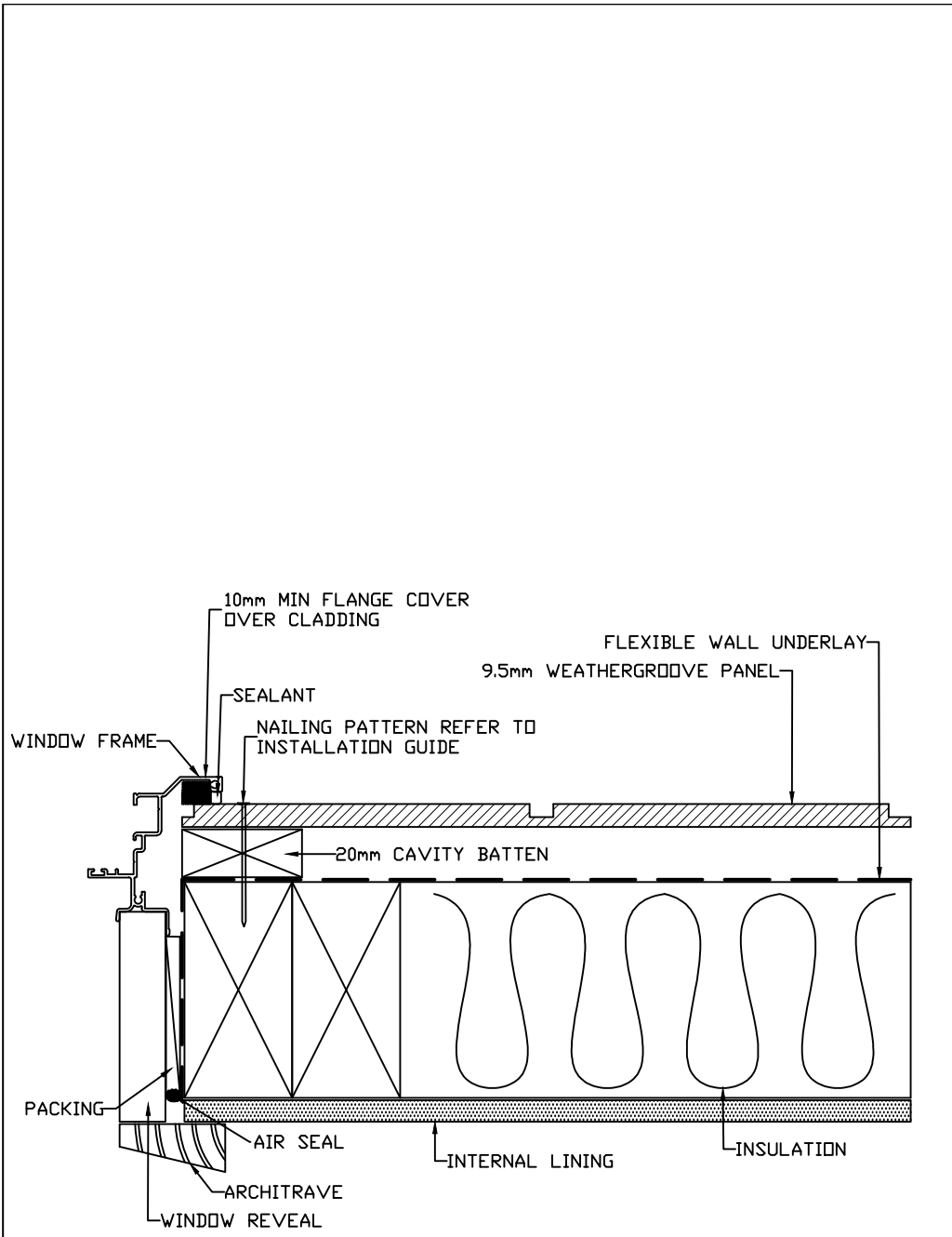

WINDOW JAMB DETAIL

A

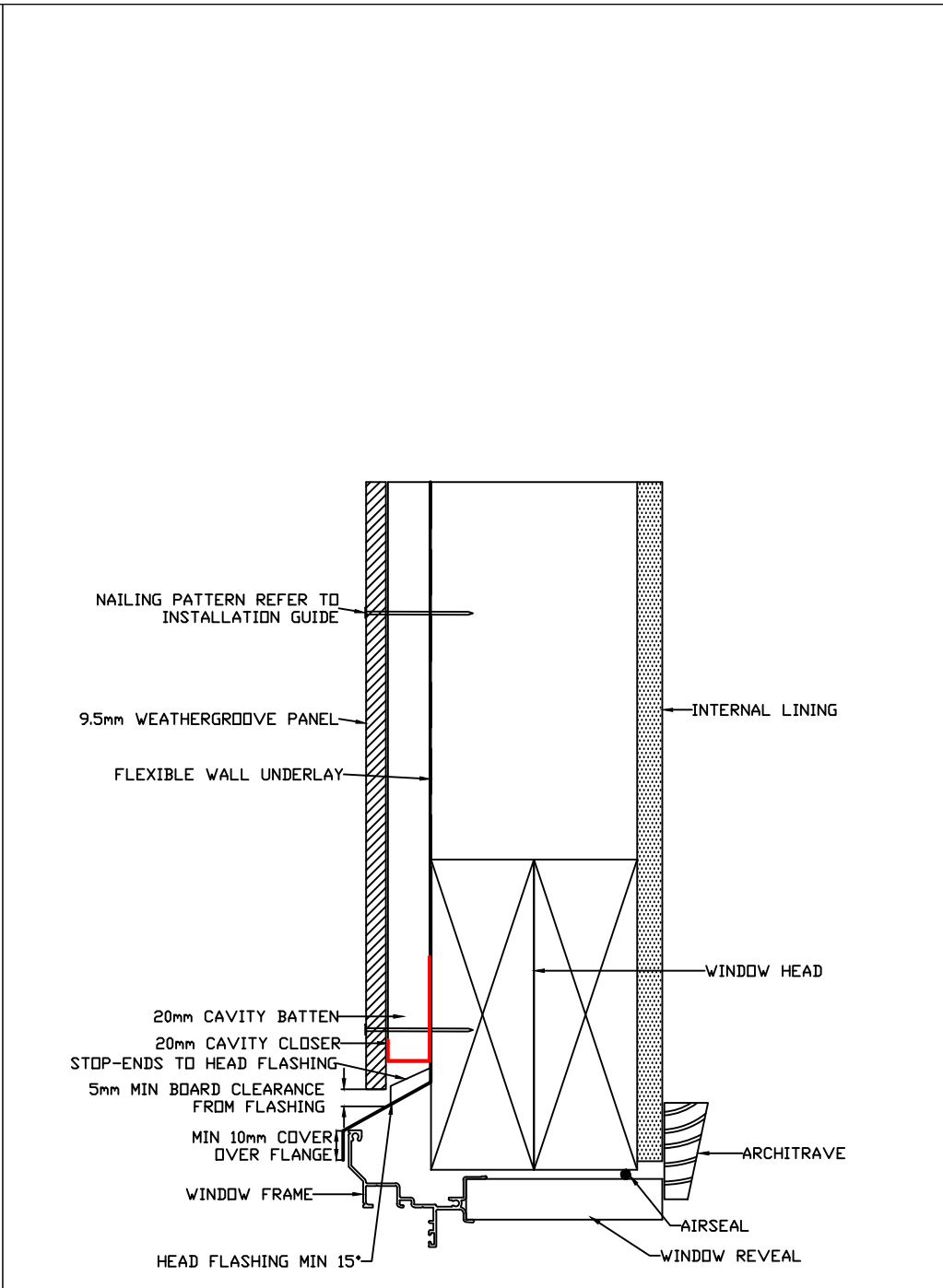

LINTEL DETAIL

NOTE: IN WIND AREAS OF VERY HIGH AND ABOVE, SEALANT MUST BE INSTALLED BETWEEN UNDERSIDE OF THE HEAD FLASHING AND TOP OF THE WINDOW HEAD FLANGE

B

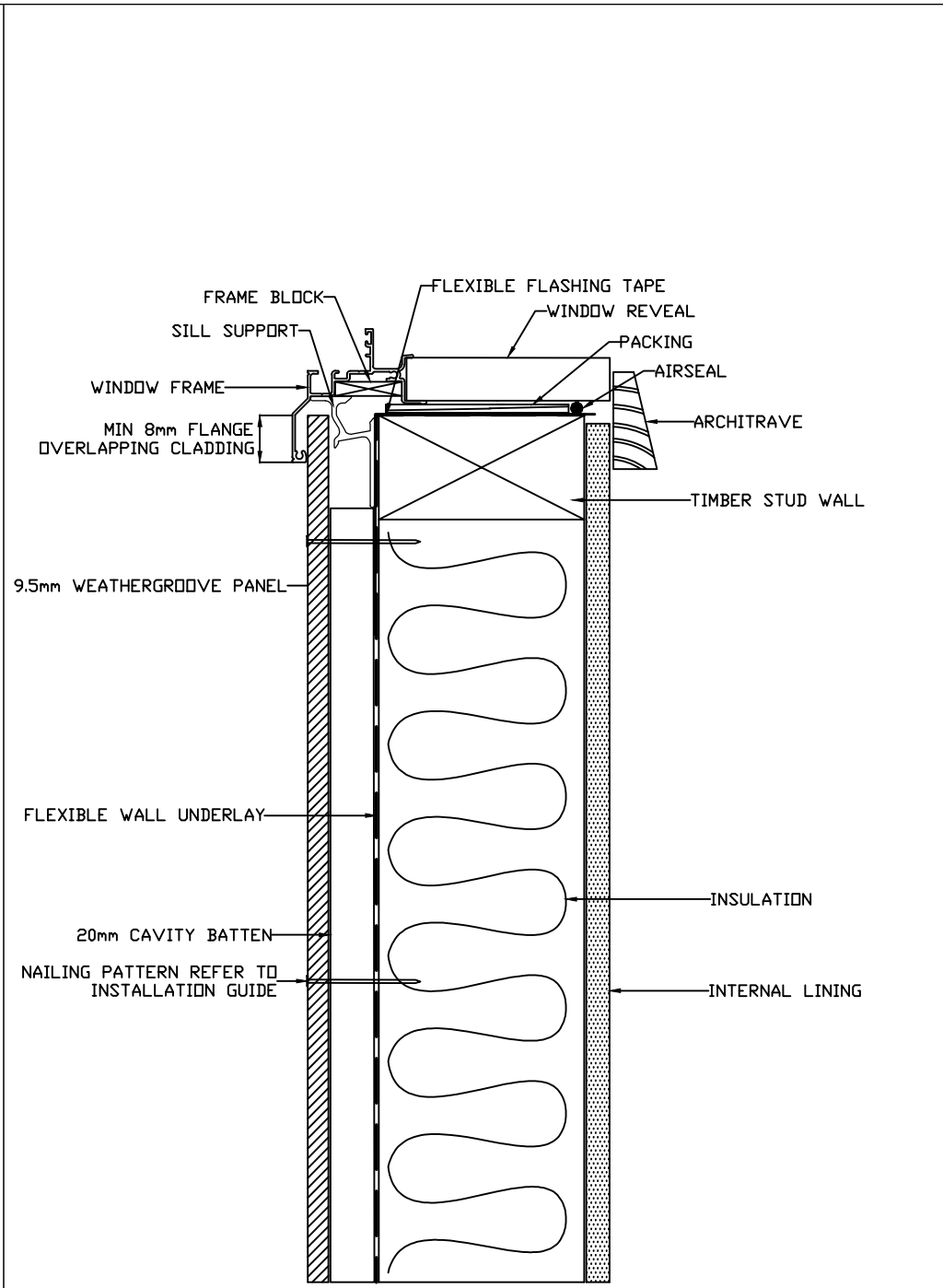

WINDOW SILL DETAIL

C



DRAWING NAME:
 20mm CAVITY INSTALLATION - WEATHERGROOVE

SCALE:
 NTS

DRAWN BY:
 A.MOATE

CHECKED BY:
 C.O'NEILL

DATE:
 29.04.19

DRAWING No.:
 CD-WG-C20-05

SHT SIZE
 A3

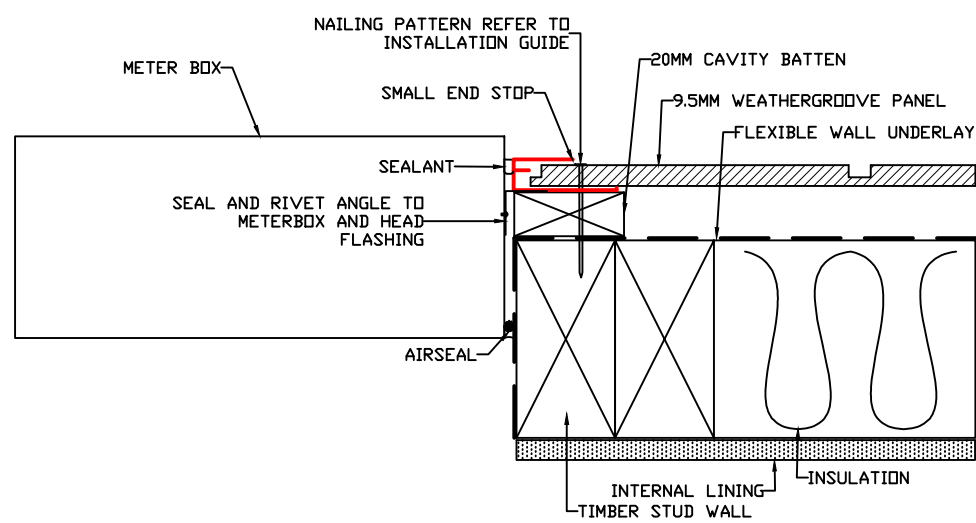

METER BOX JAMB
DETAIL

A

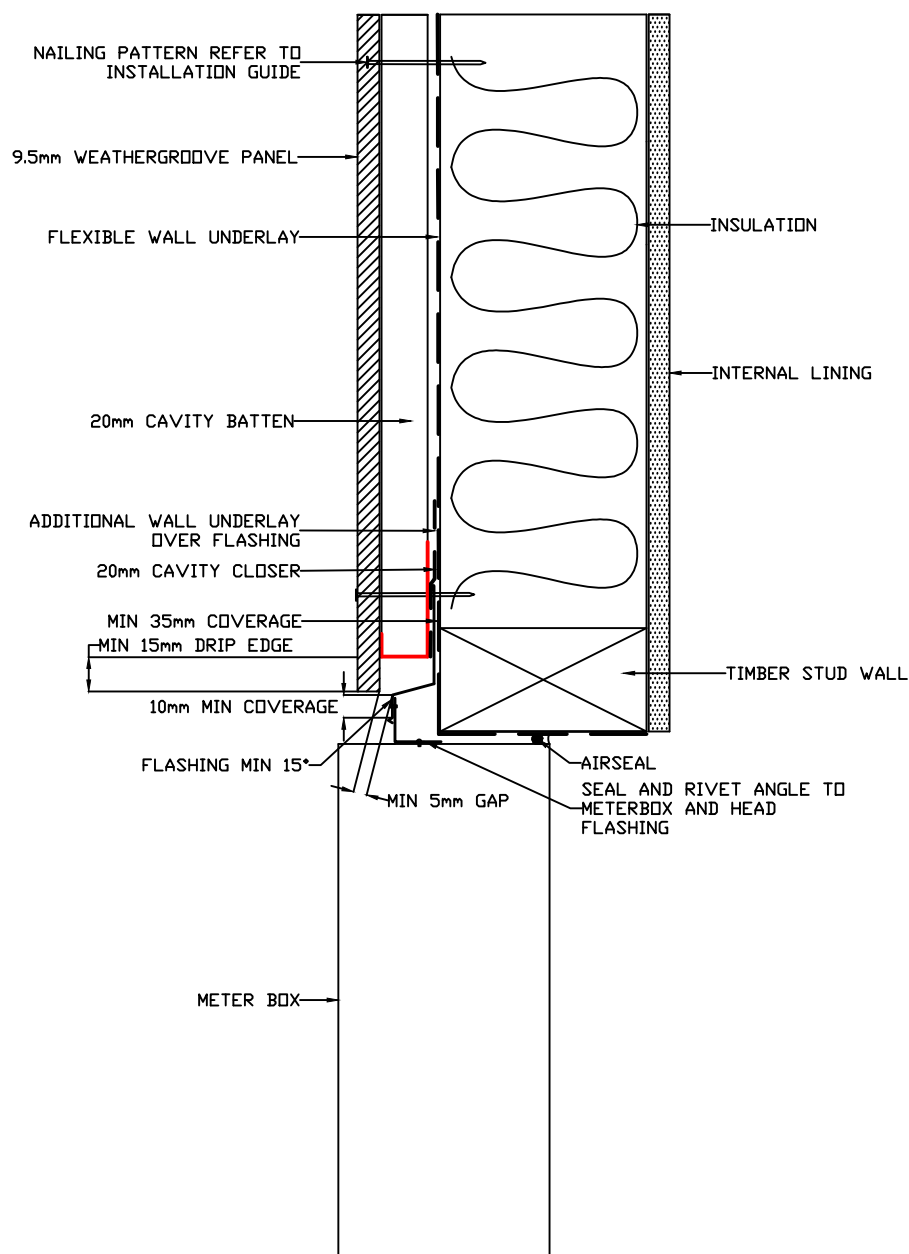

METER BOX HEAD
DETAIL

B

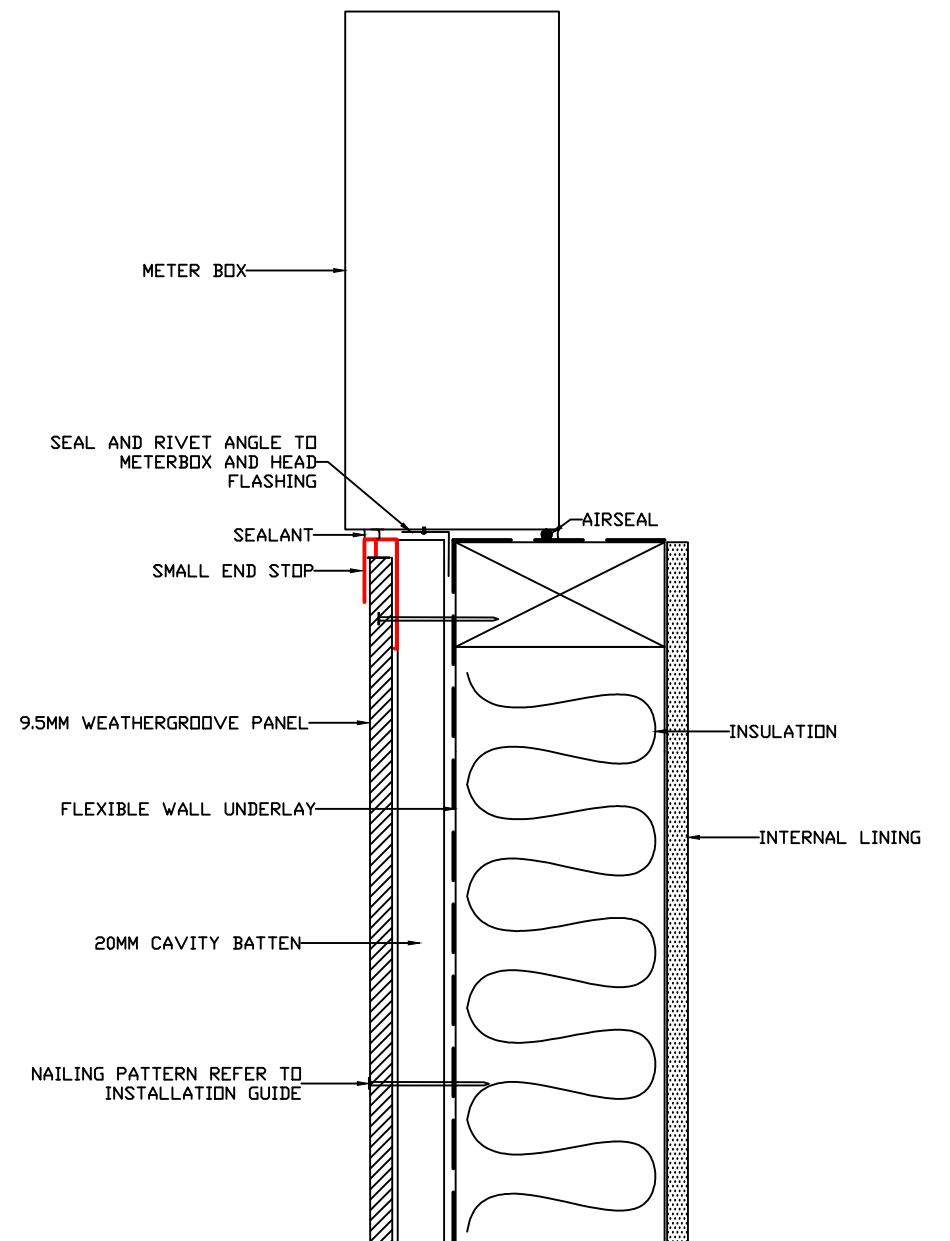

METER BOX SILL
DETAIL

C



DRAWING NAME:
20mm CAVITY INSTALLATION - WEATHERGROOVE

SCALE:
NTS

DRAWN BY:
A.MOATE

CHECKED BY:
C.O'NEILL

DATE:
29.04.19

DRAWING No.:
CD-WG-C20-06

SHT SIZE
A3

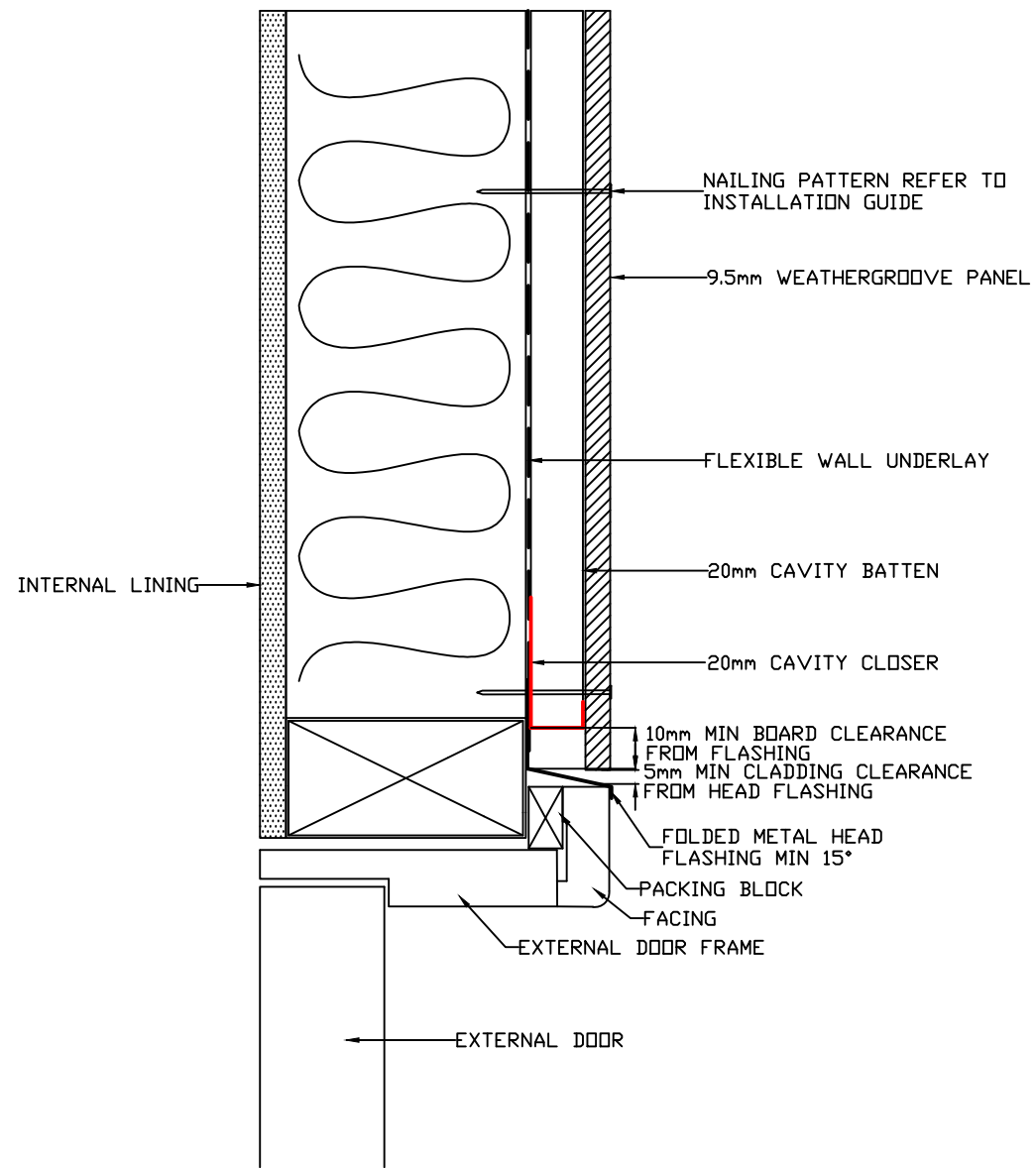

DOOR HEADER DETAIL

A



DRAWING NAME:
20mm CAVITY INSTALLATION - WEATHERGROOVE

SCALE:
NTS

DRAWN BY:
A.MOATE

CHECKED BY:
C.O'NEILL

DATE:
29.04.19

DRAWING No.:
CD-WG-C20-07

SHT SIZE
A3

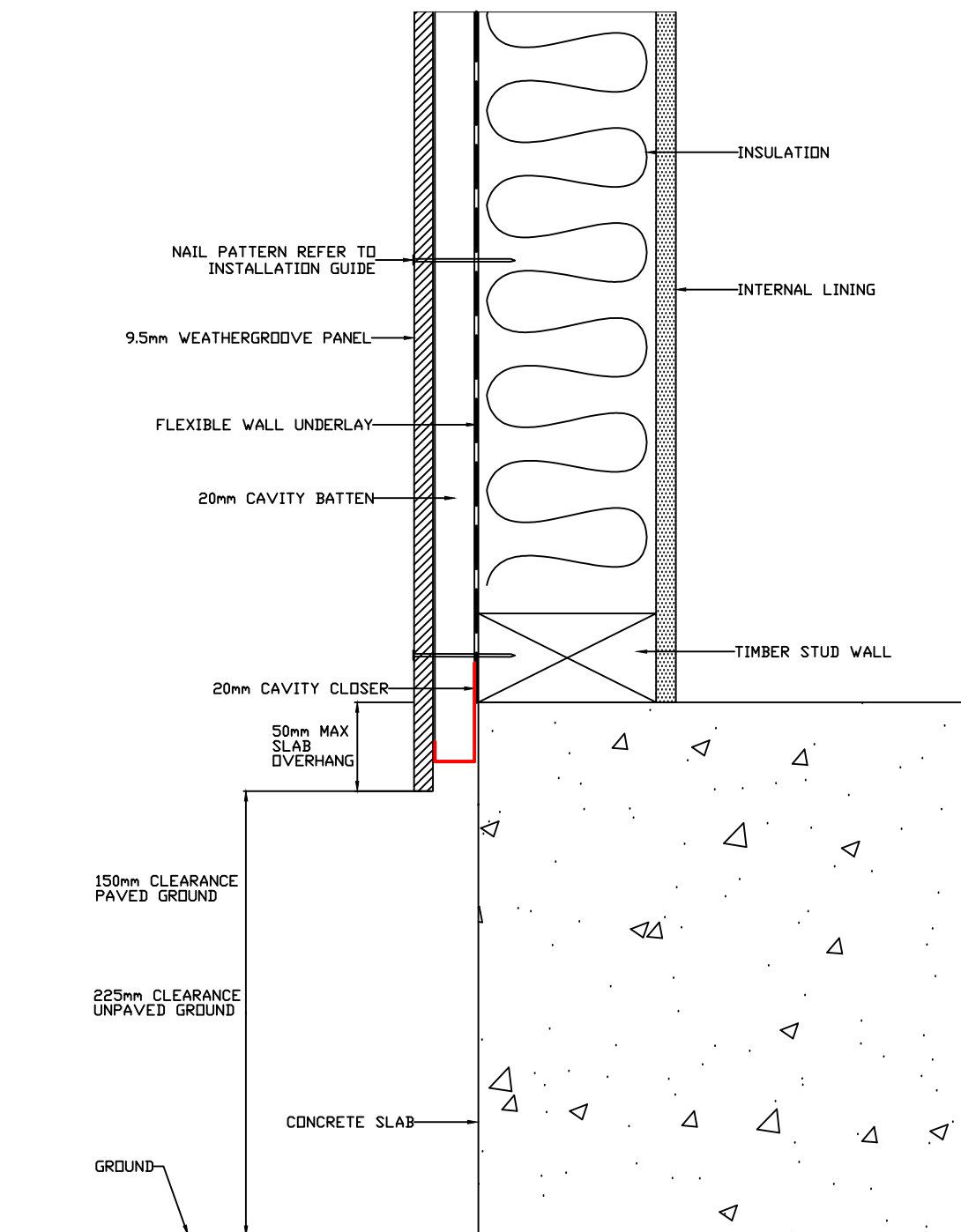

CONCRETE SLAB
GROUND CLEARANCE DETAIL

A



DRAWING NAME:
20mm CAVITY INSTALLATION - WEATHERGROOVE

SCALE:
NTS

DRAWN BY:
A.MOATE

CHECKED BY:
C.O'NEILL

DATE:
29.04.19

DRAWING No.:
CD-WG-C20-08

SHT SIZE
A3

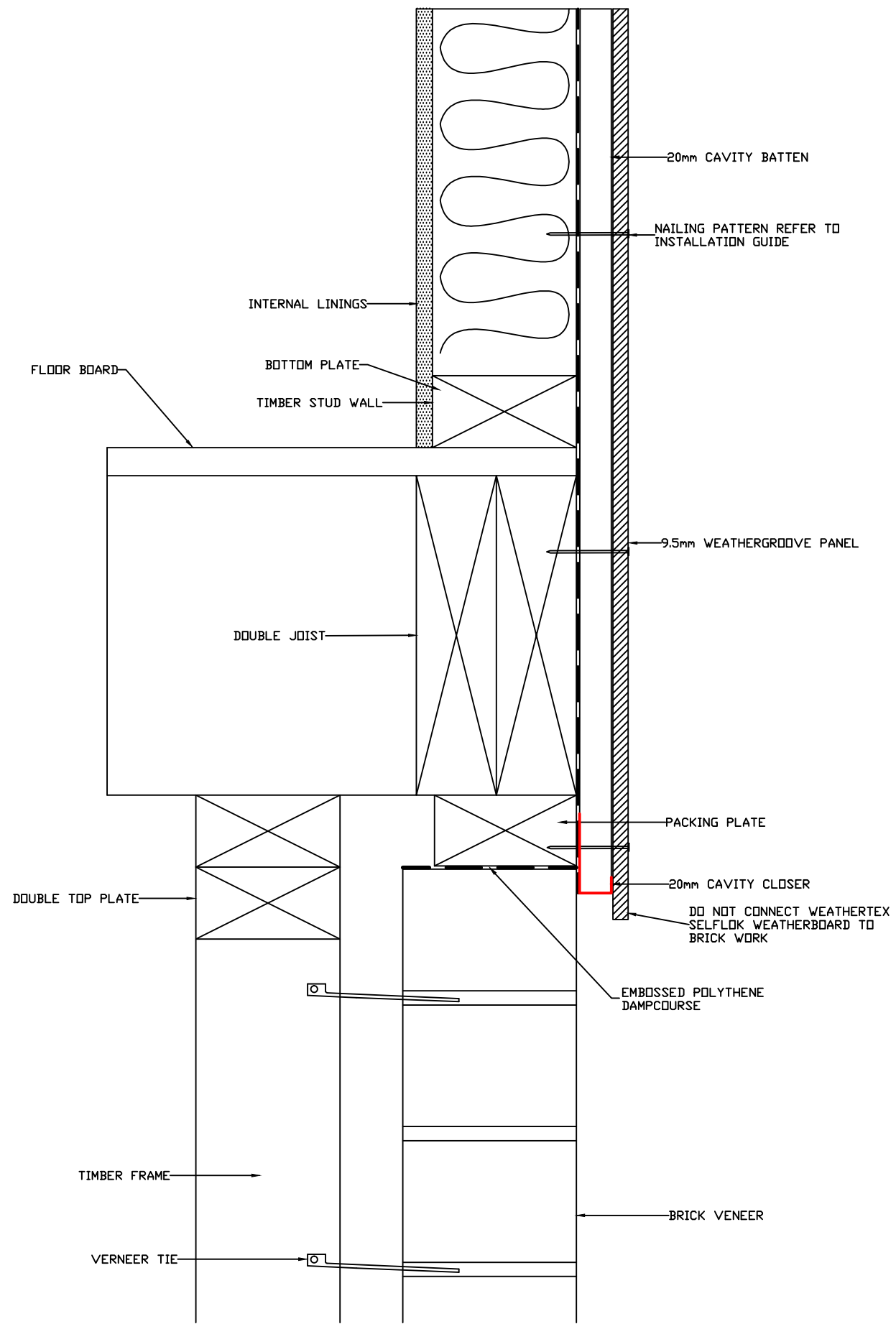

FLUSH WITH BRICK VENEER DETAIL

A



DRAWING NAME:
20mm CAVITY INSTALLATION - WEATHERGROOVE

SCALE:
NTS

DRAWN BY:
A.MOATE

CHECKED BY:
C.O'NEILL

DATE:
29.04.19

DRAWING No.:
CD-WG-C20-09

SHT SIZE
A3

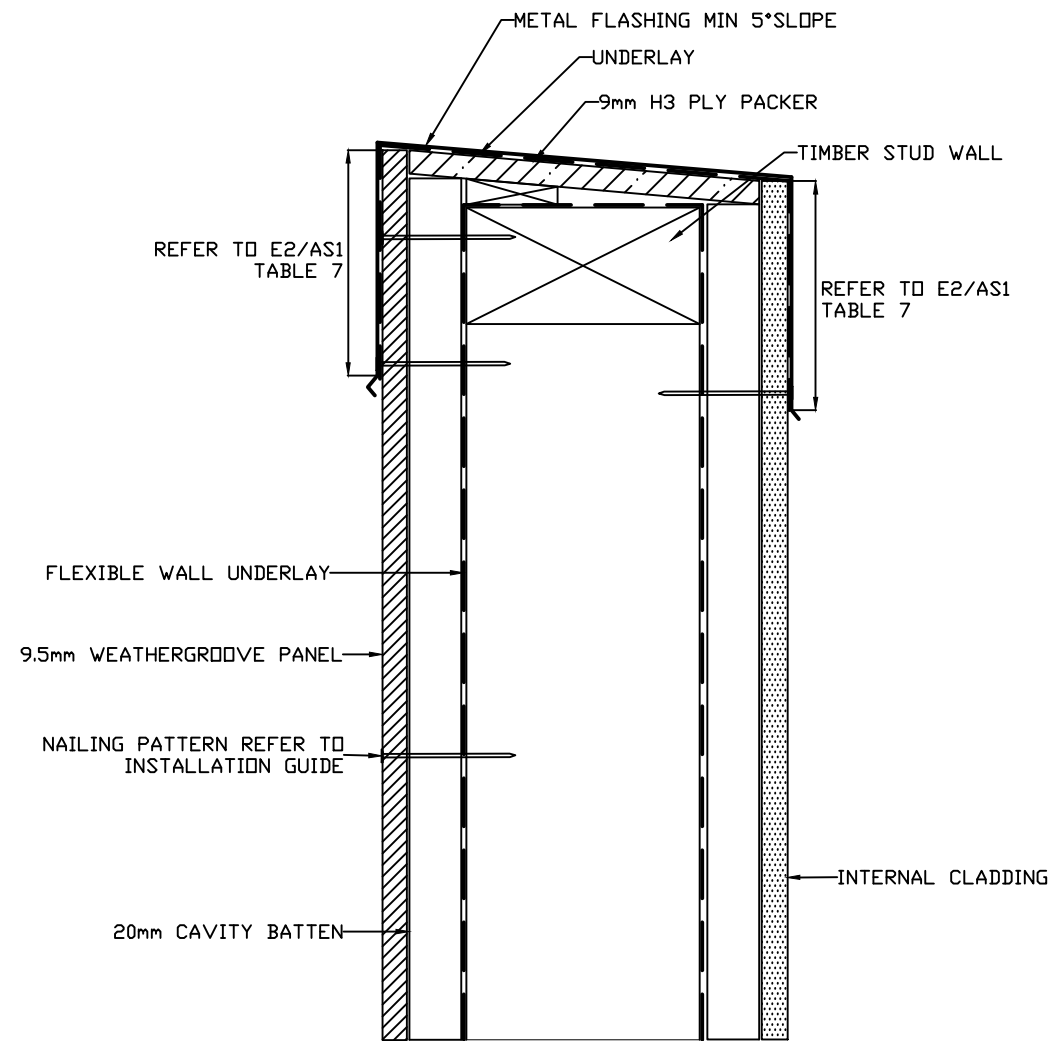

PARAPET DETAIL

FOR BALUSTRADE/WALL JUNCTION REFER TO E2/AS1 FIG. 11 & 12

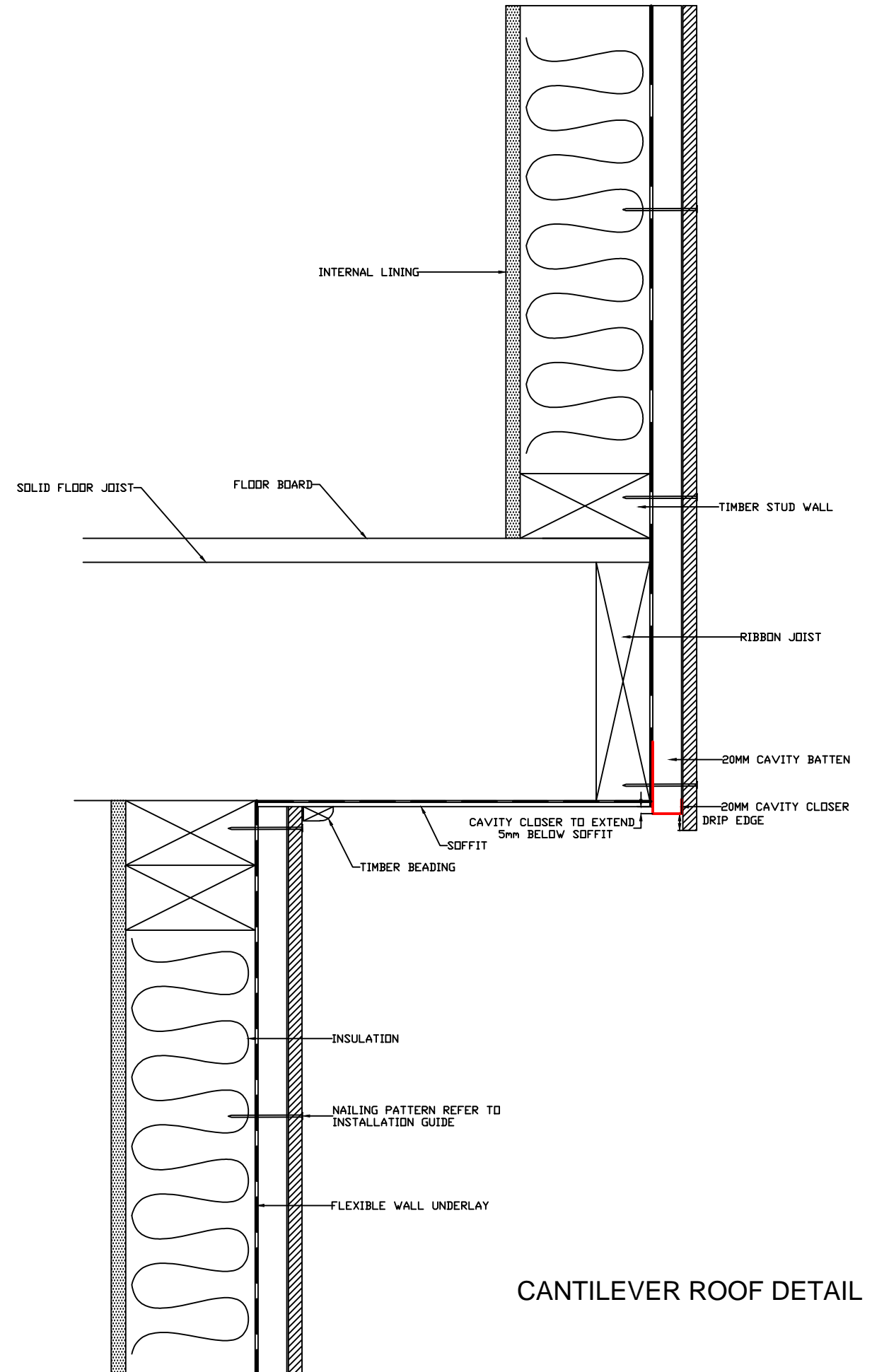

CANTILEVER ROOF DETAIL

A

B



DRAWING NAME:
20mm CAVITY INSTALLATION - WEATHERGROOVE

SCALE:
NTS

DRAWN BY:
A.MOATE

CHECKED BY:
C.O'NEILL

DATE:
29.04.19

DRAWING No.:
CD-WG-C20-10

SHT SIZE
A3

ROOF CLEARANCE DETAIL

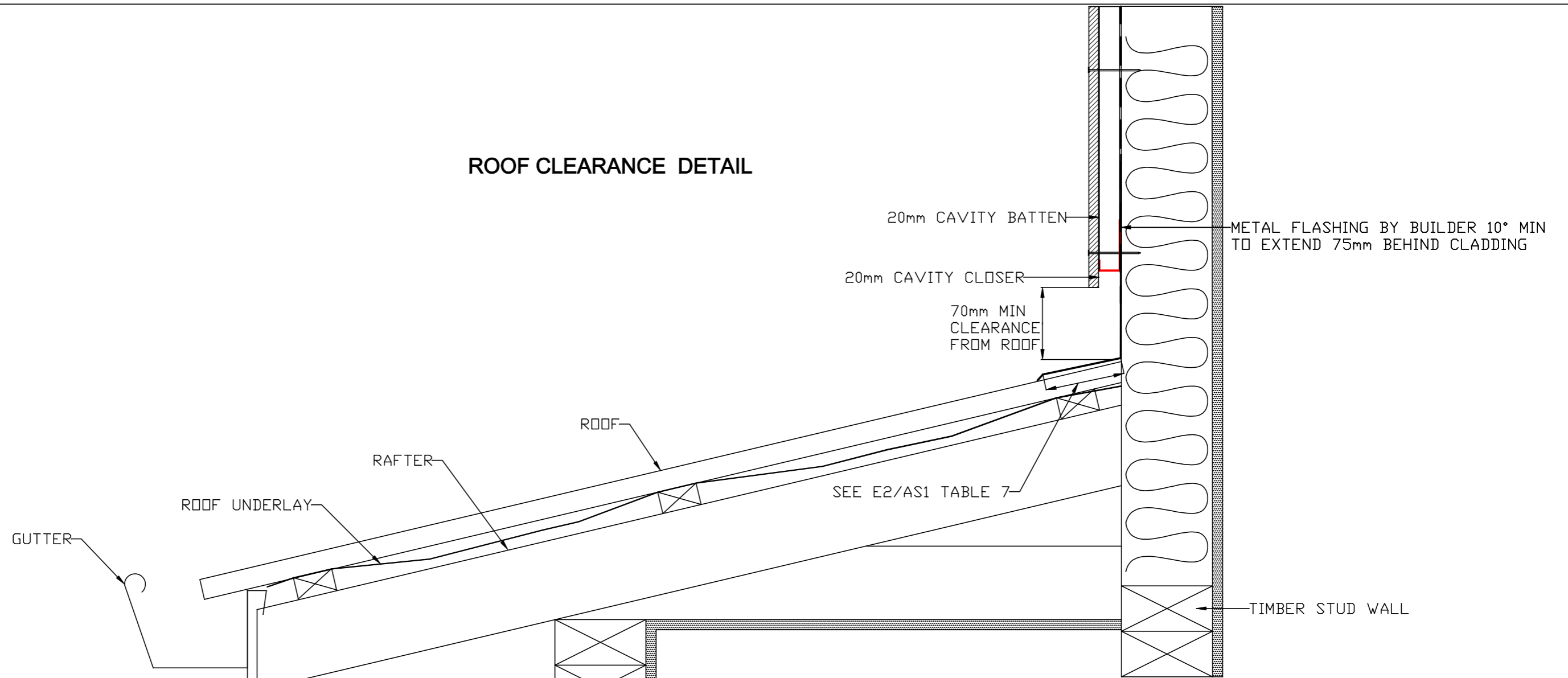

EAVE DETAIL

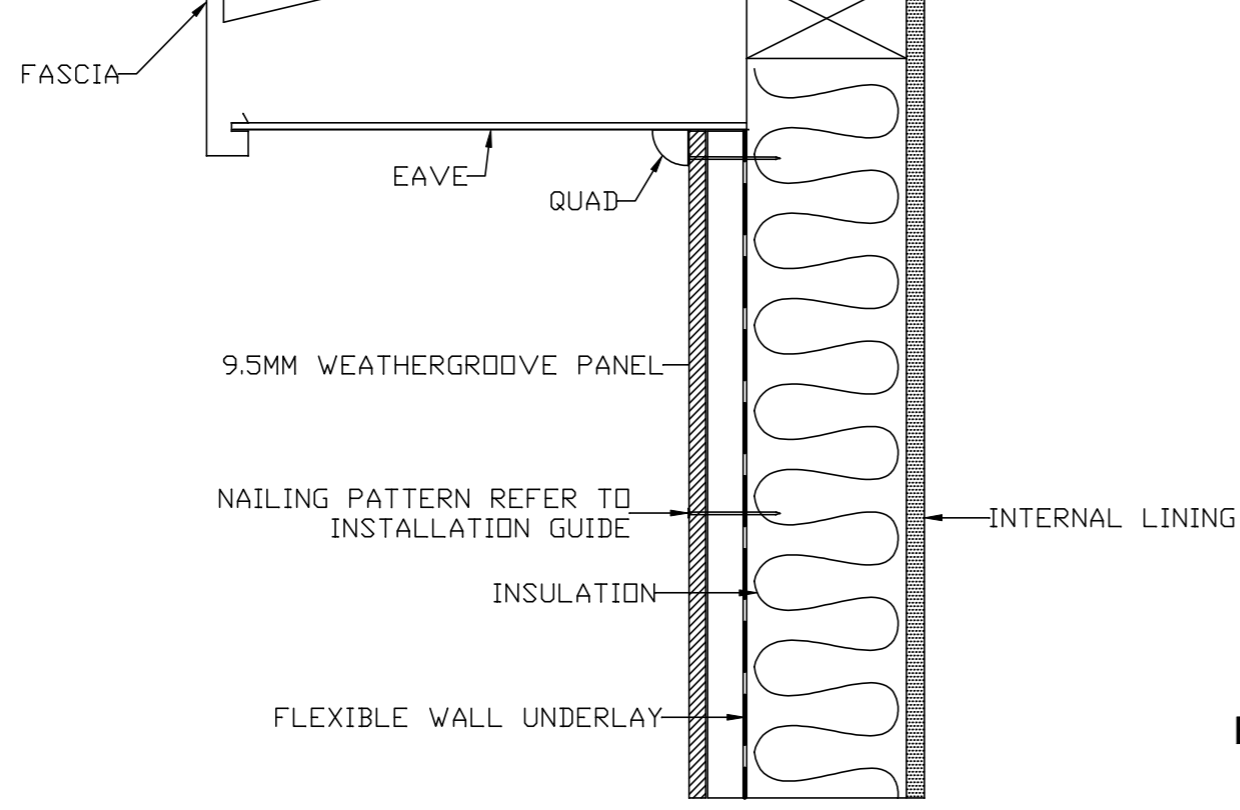

EAVE AND ROOF CLEARANCE DETAIL

	DRAWING NAME:	SCALE:	DRAWN BY:	CHECKED BY:	DATE:	DRAWING No.:	SHT SIZE
	20mm CAVITY INSTALLATION - WEATHERGROOVE	NTS	A.MOATE	C.O'NEILL	27.05.21	CD-WG-C20-11	A3