

WEATHERTEX CONSTRUCTION DETAIL GUIDE

PRIMELOK WEATHERBOARDS

DIRECT FIX CONSTRUCTION



PRIMELOK WEATHERBOARDS | DIRECT FIX CONSTRUCTION

These drawings are for information only. They do not contain full details required for construction and must be used in conjunction with the current issue Weathertex Installation Manual, New Zealand Construction Code, E2/AS1 and any other Local Regulations. Weathertex recommends gaining professional advice to ensure the drawings are suitable for your project. Weathertex accepts no liability in respect to the use of these drawings.

PAGE 3

PRIMELOK FIXING DETAIL

PAGE 4

OFF STUD TRADITIONAL JOINER DETAIL

PAGE 5

LARGE TRADITIONAL INTERNAL "W" CORNER DETAIL

LARGE TRADITIONAL EXTERNAL "BOX" CORNER DETAIL

PAGE 6

WINDOW JAMB DETAIL

LINTEL DETAIL

WINDOW SILL DETAIL

PAGE 7

METER BOX JAMB DETAIL

METER BOX HEAD DETAIL

METER BOX SILL DETAIL

PAGE 8

DOOR HEADER DETAIL

PAGE 9

CONCRETE SLAB GROUND CLEARANCE DETAIL

PAGE 10

FLUSH WITH BRICK VENEER DETAIL

PAGE 11

CANTILEVER ROOF DETAIL DETAIL

PAGE 12

EAVE AND ROOF CLEARANCE DETAIL

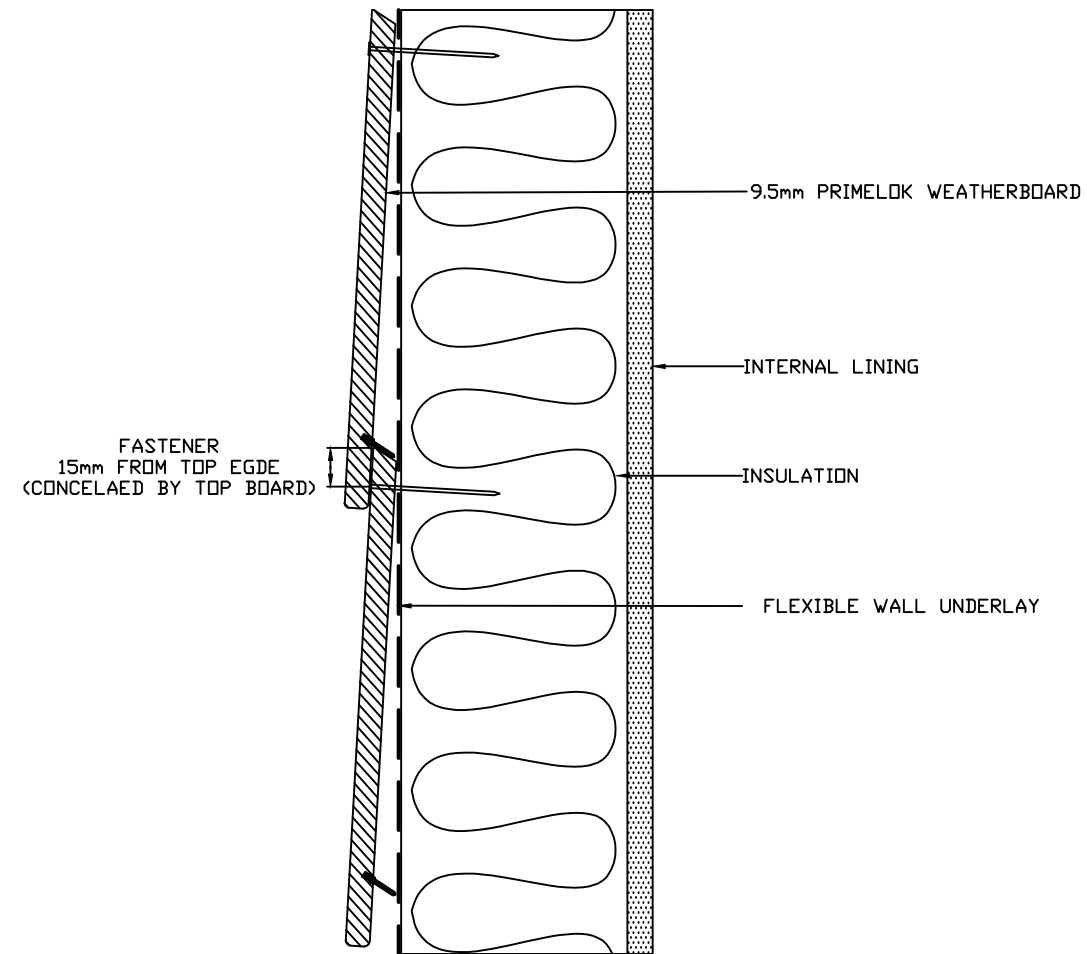

PRIMELOK FIXING
DETAIL

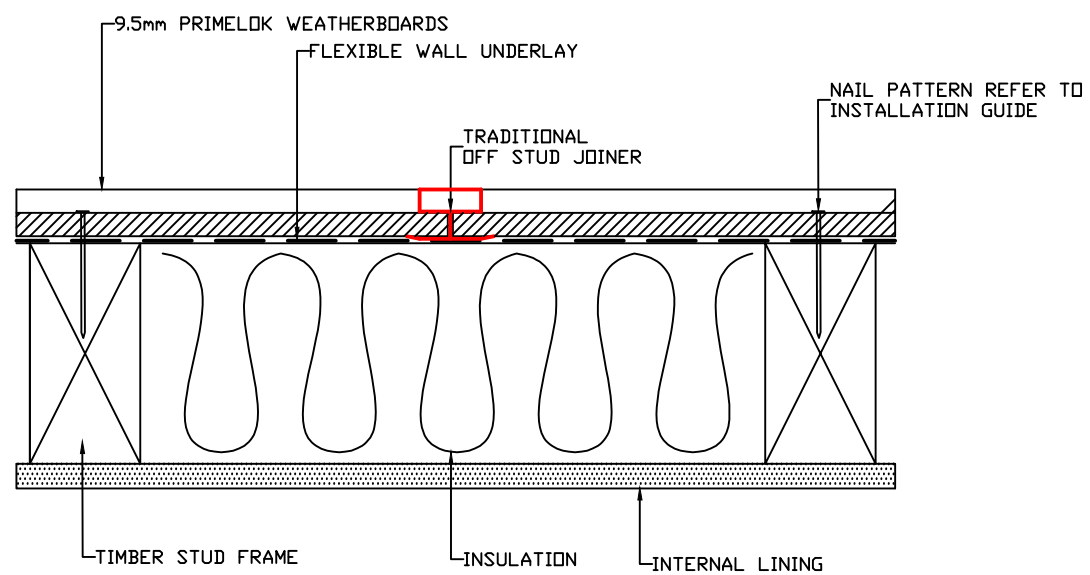

OFF STUD TRADITIONAL JOINER DETAIL

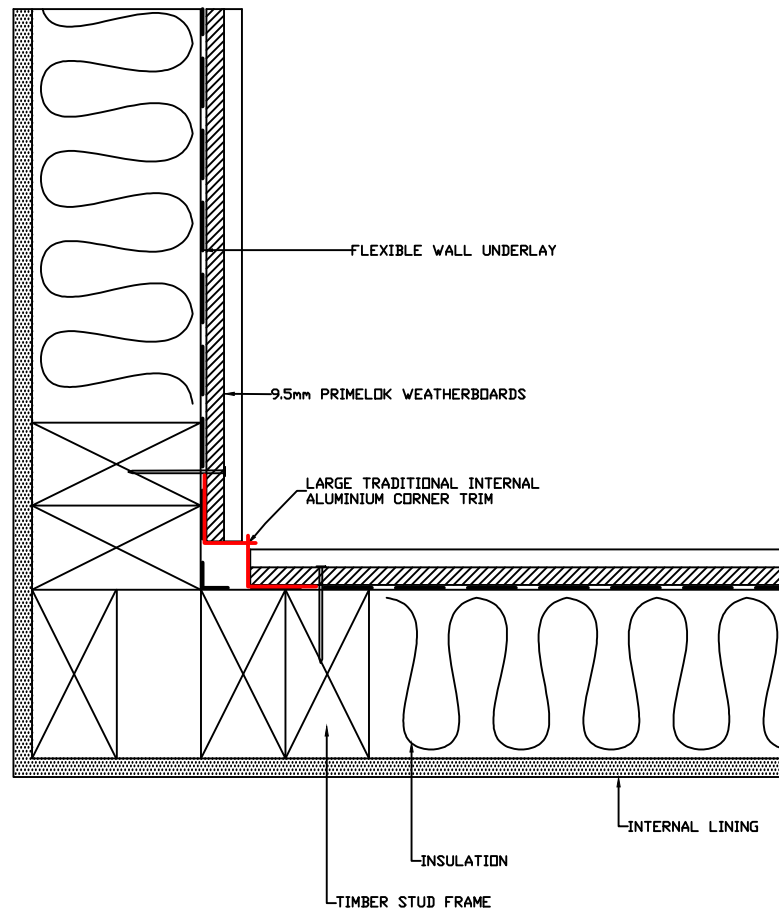

A LARGE TRADITIONAL INTERNAL "W" CORNER DETAIL

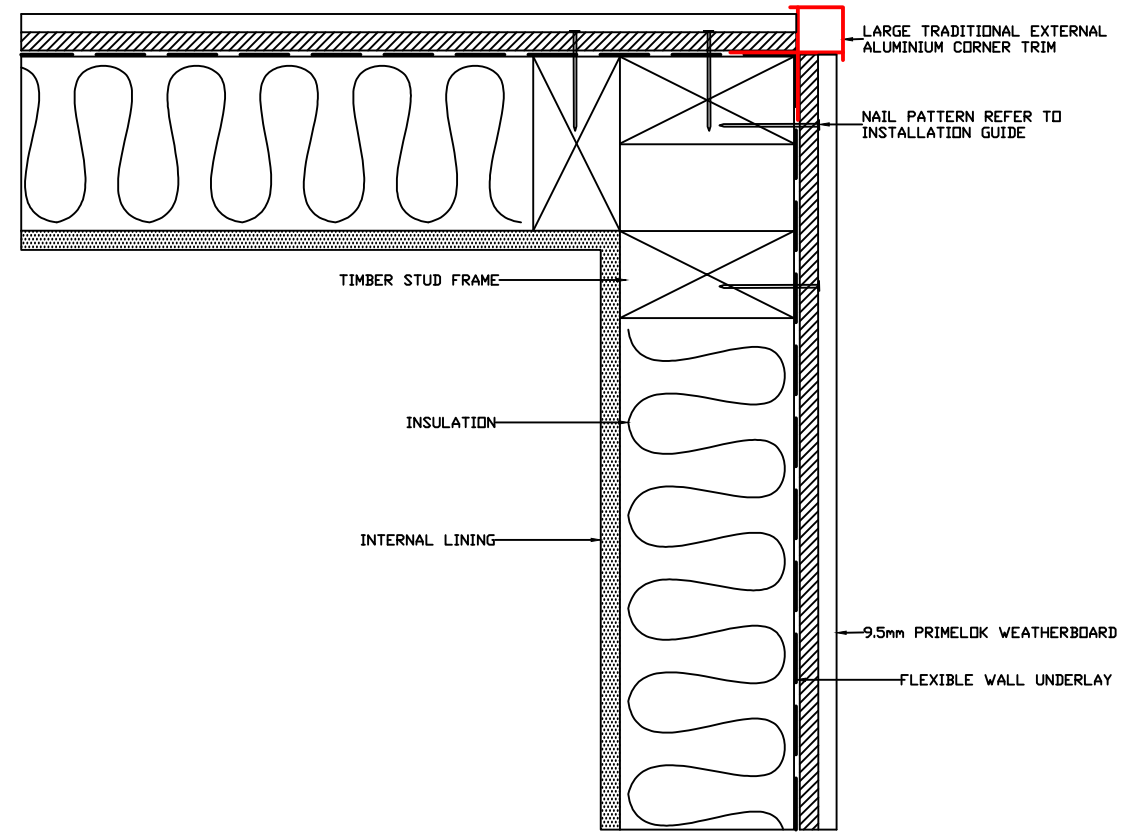

B LARGE TRADITIONAL EXTERNAL "BOX" CORNER DETAIL



DRAWING NAME:
NZ DIRECT FIX INSTALLATION - PRIMELOK

SCALE:
NTS

DRAWN BY:
A.MOATE

CHECKED BY:
C.O'NEILL

DATE:
12.12.19

DRAWING No.:
CD-PL-C20-03

SHT SIZE
A3

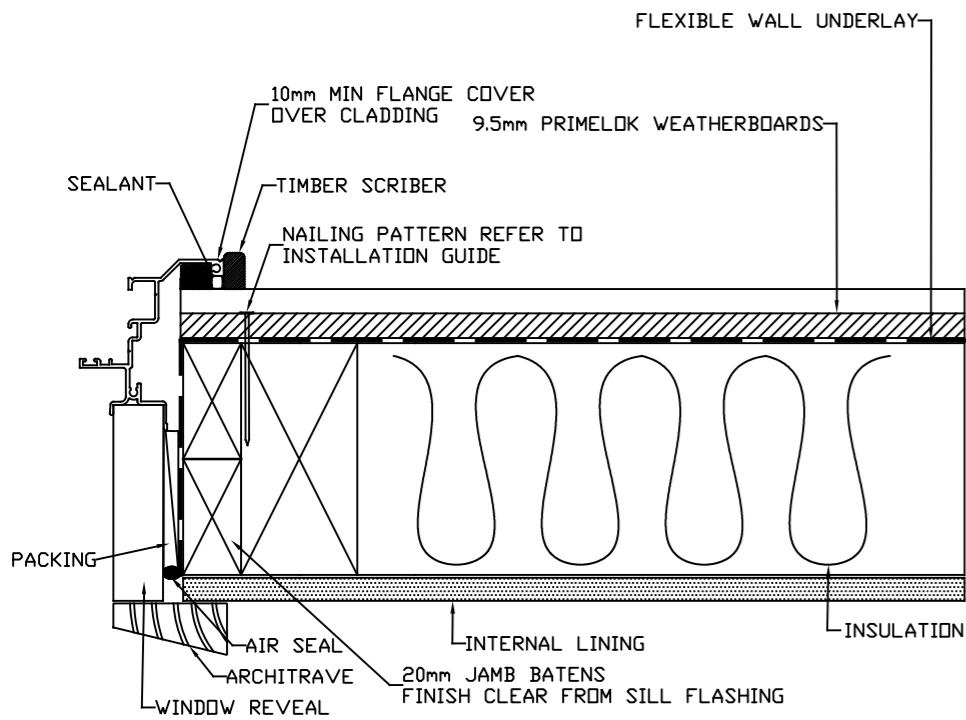

WINDOW JAMB DETAIL

A

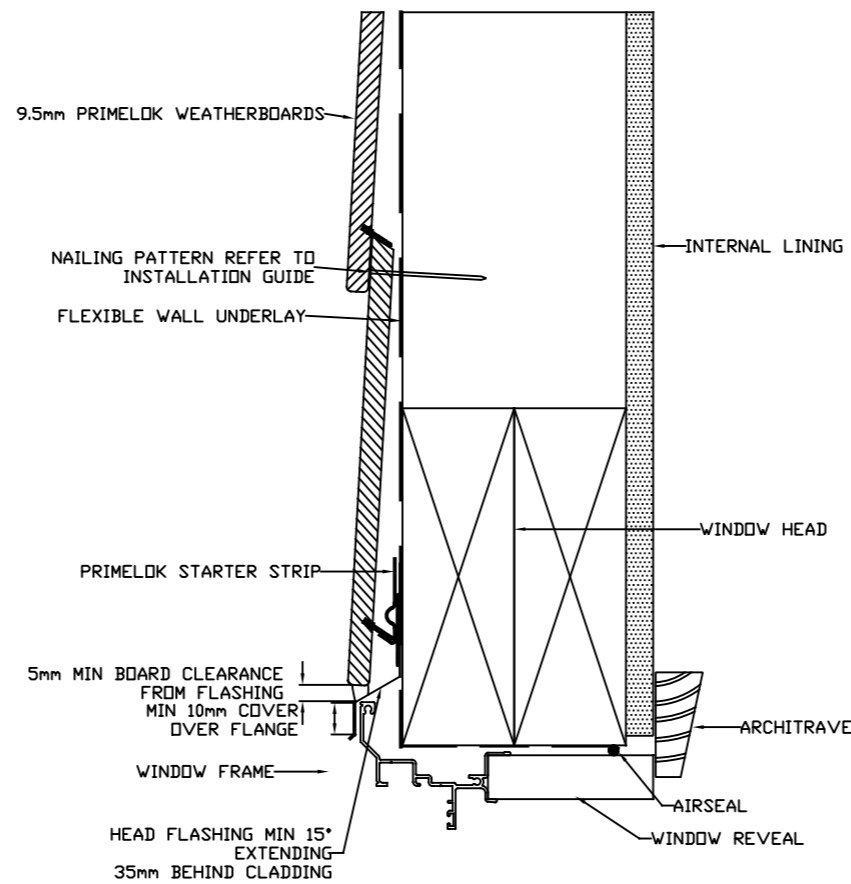

LINTEL DETAIL

NOTE: IN WIND AREAS OF VERY HIGH AND ABOVE, SEALANT MUST BE INSTALLED BETWEEN UNDERSIDE OF THE HEAD FLASHING AND TOP OF THE WINDOW HEAD FLANGE

NOTE 2: USE A SUITABLE PACKER ABOVE WINDOW IF OPENING DOES NOT COINCIDE WITH COURSES AND FASTEN THROUGH THE FACE OF THE BOARD AT EACH STUD

NOTE 3: HEAD FLASHING TO EXTEND 20mm PAST WINDOW FRAME

B

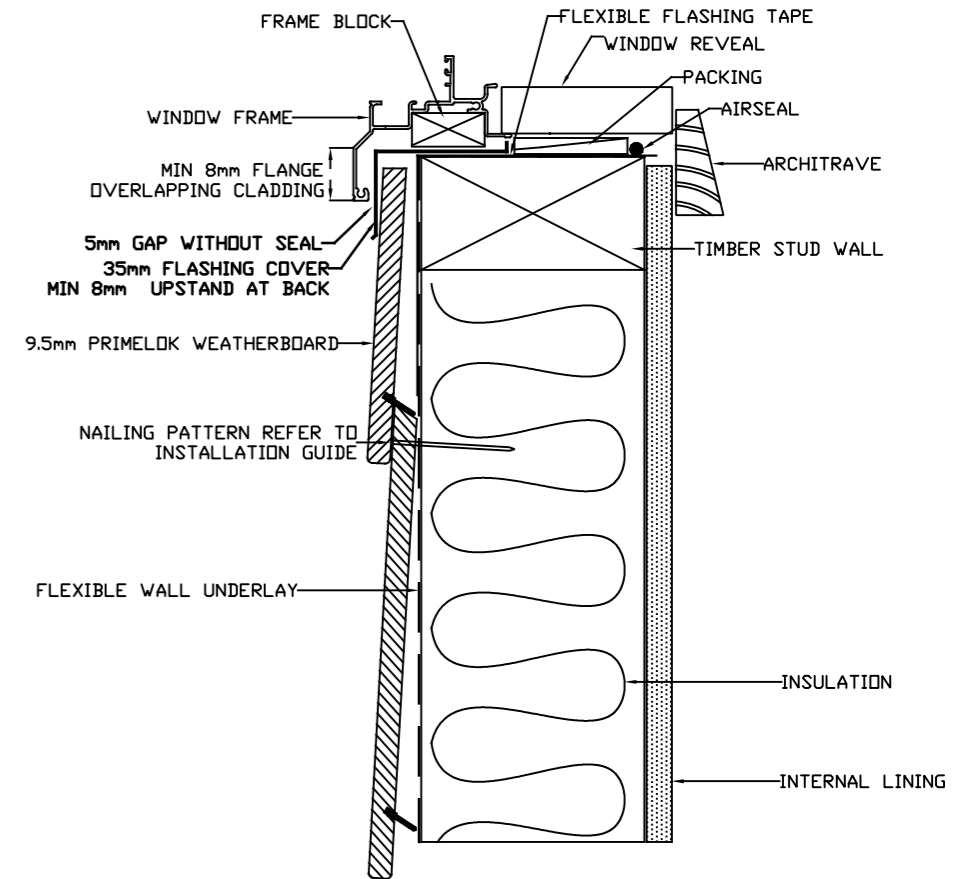

WINDOW SILL DETAIL

C



DRAWING NAME:
NZ DIRECT FIX INSTALLATION - PRIMELOK

SCALE:
NTS

DRAWN BY:
A.MOATE

CHECKED BY:
C.O'NEILL

DATE:
03.02.20

DRAWING No.:
CD-PL-C20-05

SHT SIZE
A3

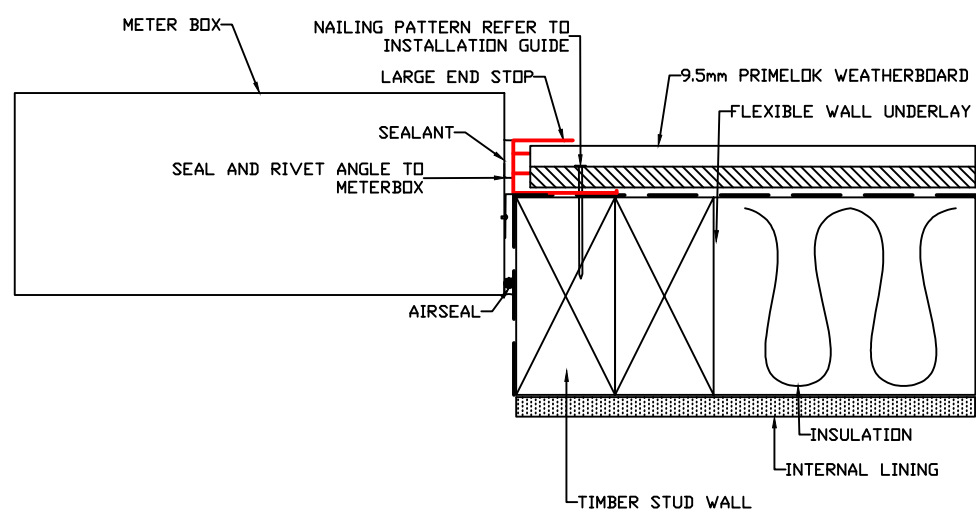

METER BOX JAMB
DETAIL

A

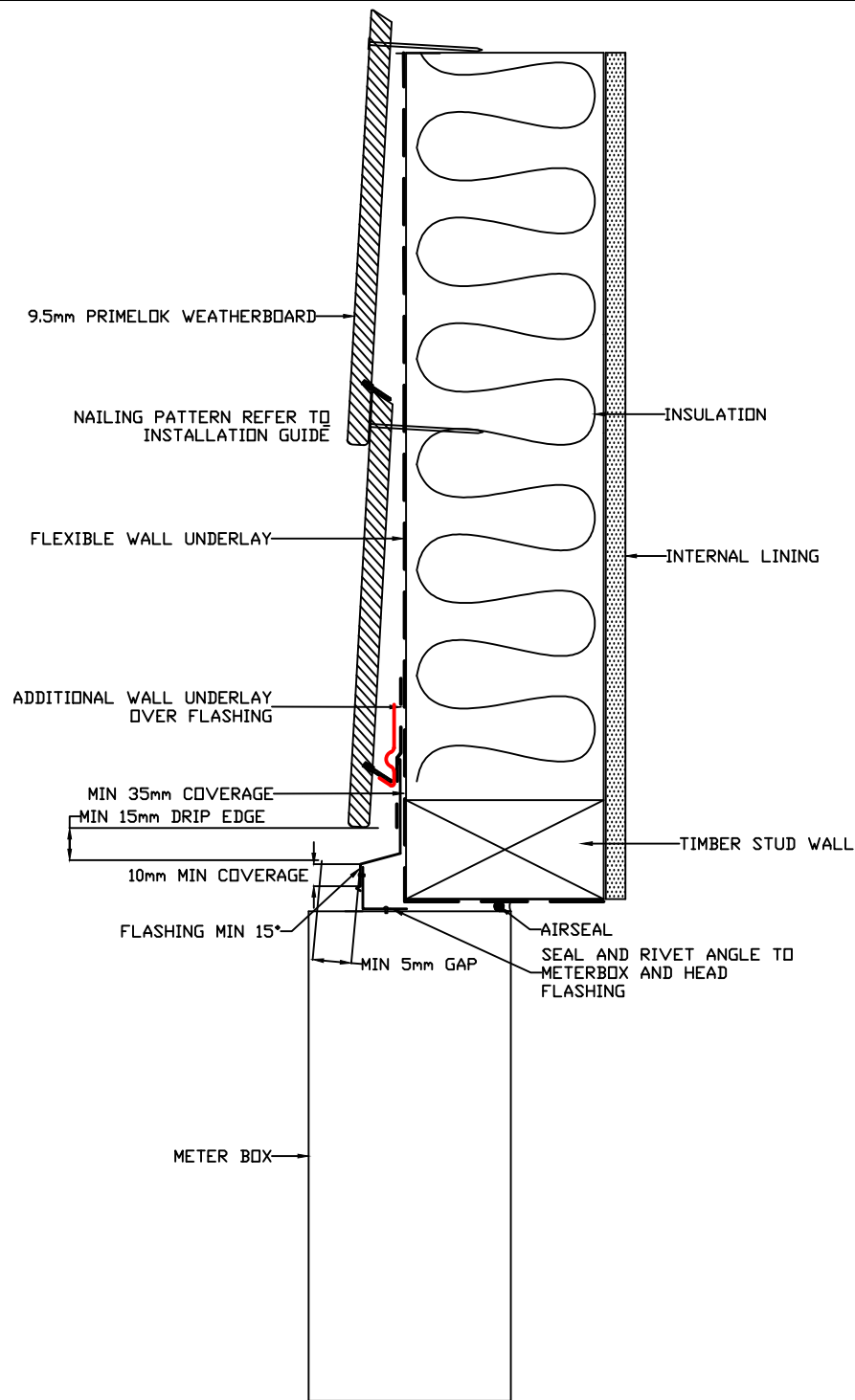

METER BOX HEAD DETAIL

REFER TO E2/AS1 FIG. 69

B

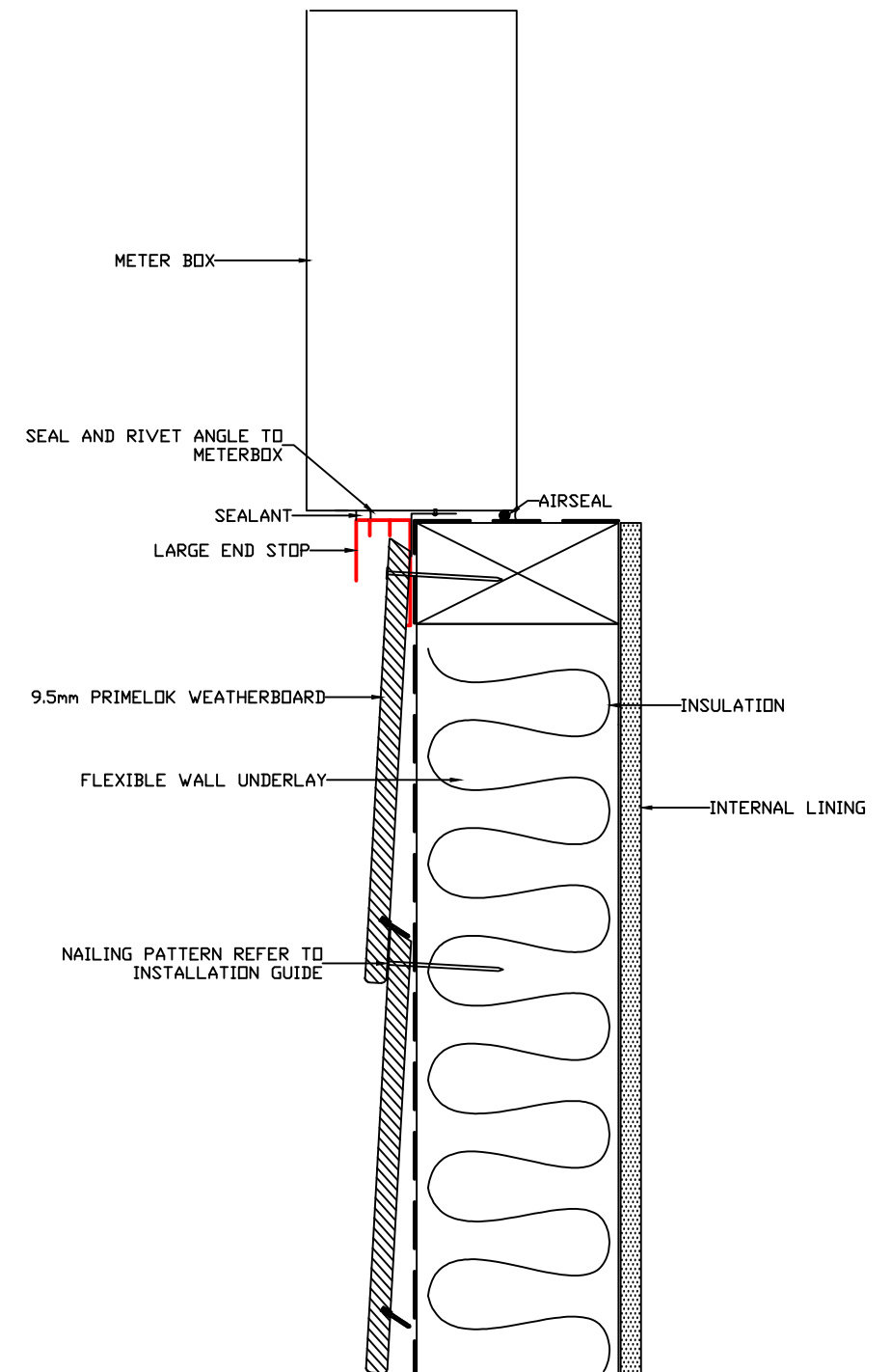

METER BOX SILL DETAIL

C



DRAWING NAME:
NZ DIRECT FIX INSTALLATION - PRIMELOK

SCALE:
NTS

DRAWN BY:
A.MOATE

CHECKED BY:
C.O'NEILL

DATE:
12.12.19

DRAWING No.:
CD-PL-C20-06

SHT SIZE
A3

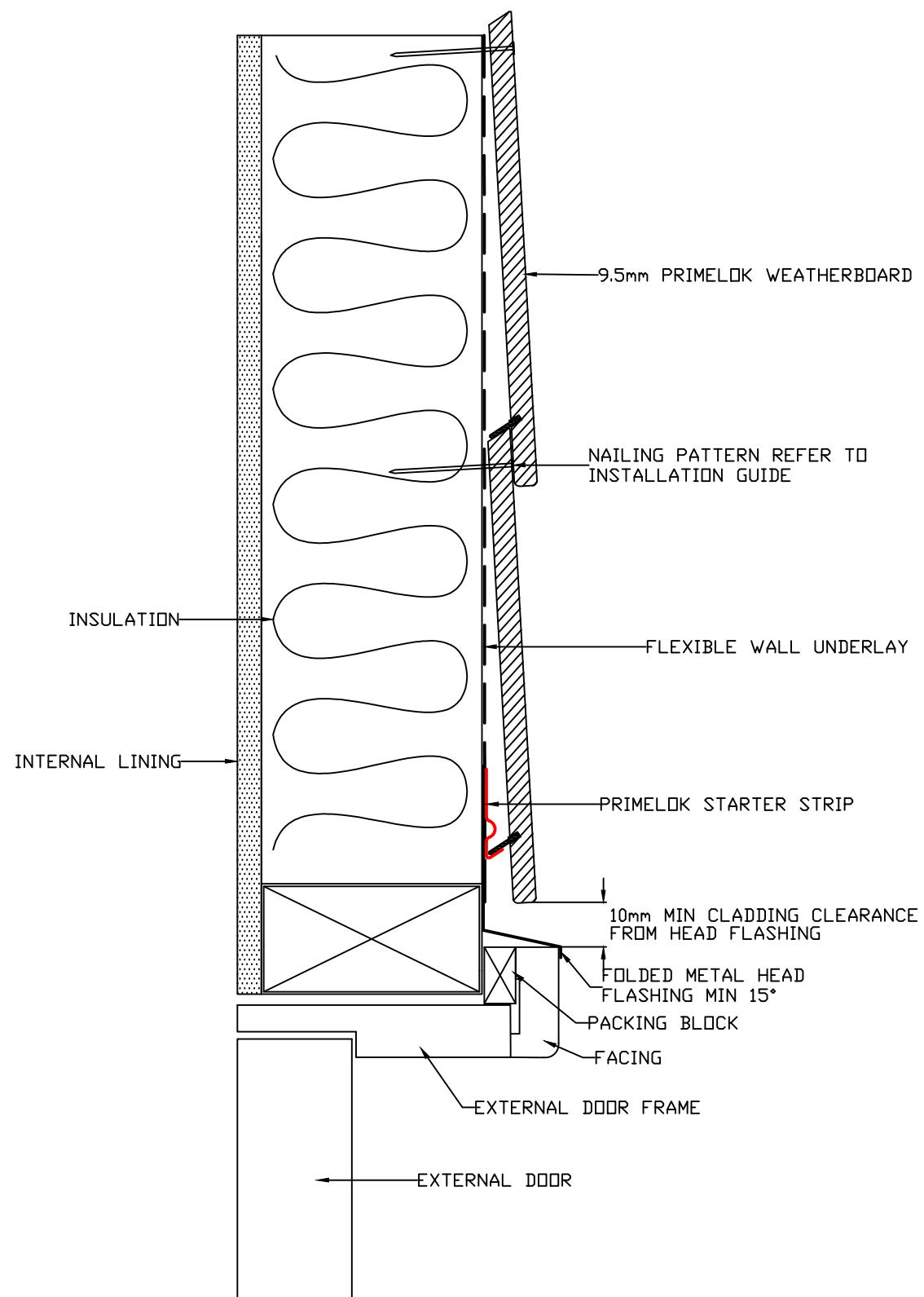

DOOR HEAD DETAIL

A



DRAWING NAME:
NZ DIRECT FIX INSTALLATION - PRIMELOK

SCALE:
NTS

DRAWN BY:
A.MOATE

CHECKED BY:
C.O'NEILL

DATE:
12.12.19

DRAWING No.:
CD-PL-C20-07

SHT SIZE
A3

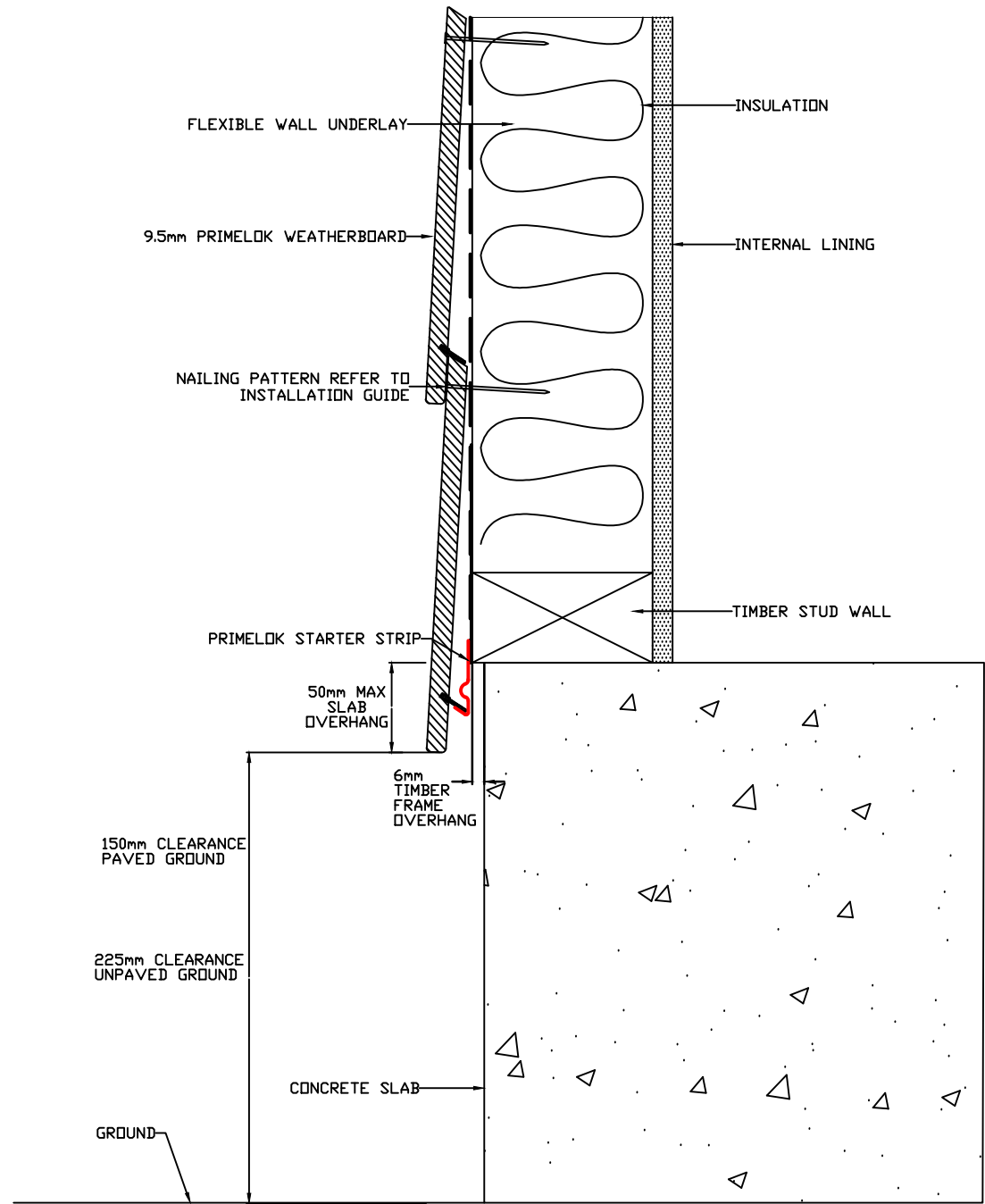

CONCRETE SLAB
GROUND CLEARANCE DETAIL

A

	DRAWING NAME: NZ DIRECT FIX INSTALLATION - PRIMELOK	SCALE: NTS	DRAWN BY: A.MOATE	CHECKED BY: C.O'NEILL	DATE: 12.12.19	DRAWING No.: CD-PL-C20-08	SHT SIZE A3
--	--	---------------	----------------------	--------------------------	-------------------	------------------------------	----------------

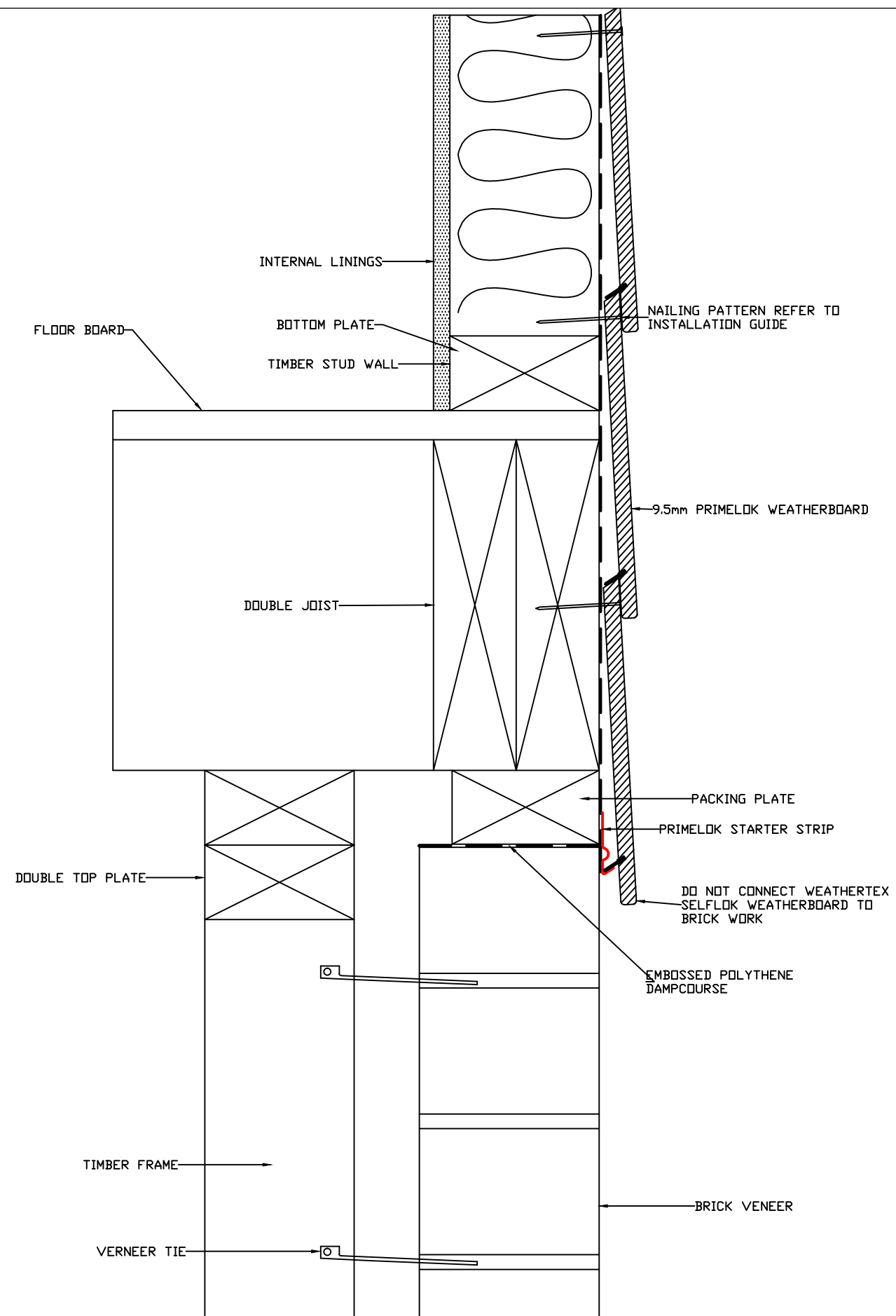

FLUSH WITH BRICK VENEER DETAIL

A



DRAWING NAME:
NZ DIRECT FIX INSTALLATION - PRIMELOK

SCALE:
NTS

DRAWN BY:
A.MOATE

CHECKED BY:
C.O'NEILL

DATE:
12.12.19

DRAWING No.:
CD-PL-C20-09

SHT SIZE
A3

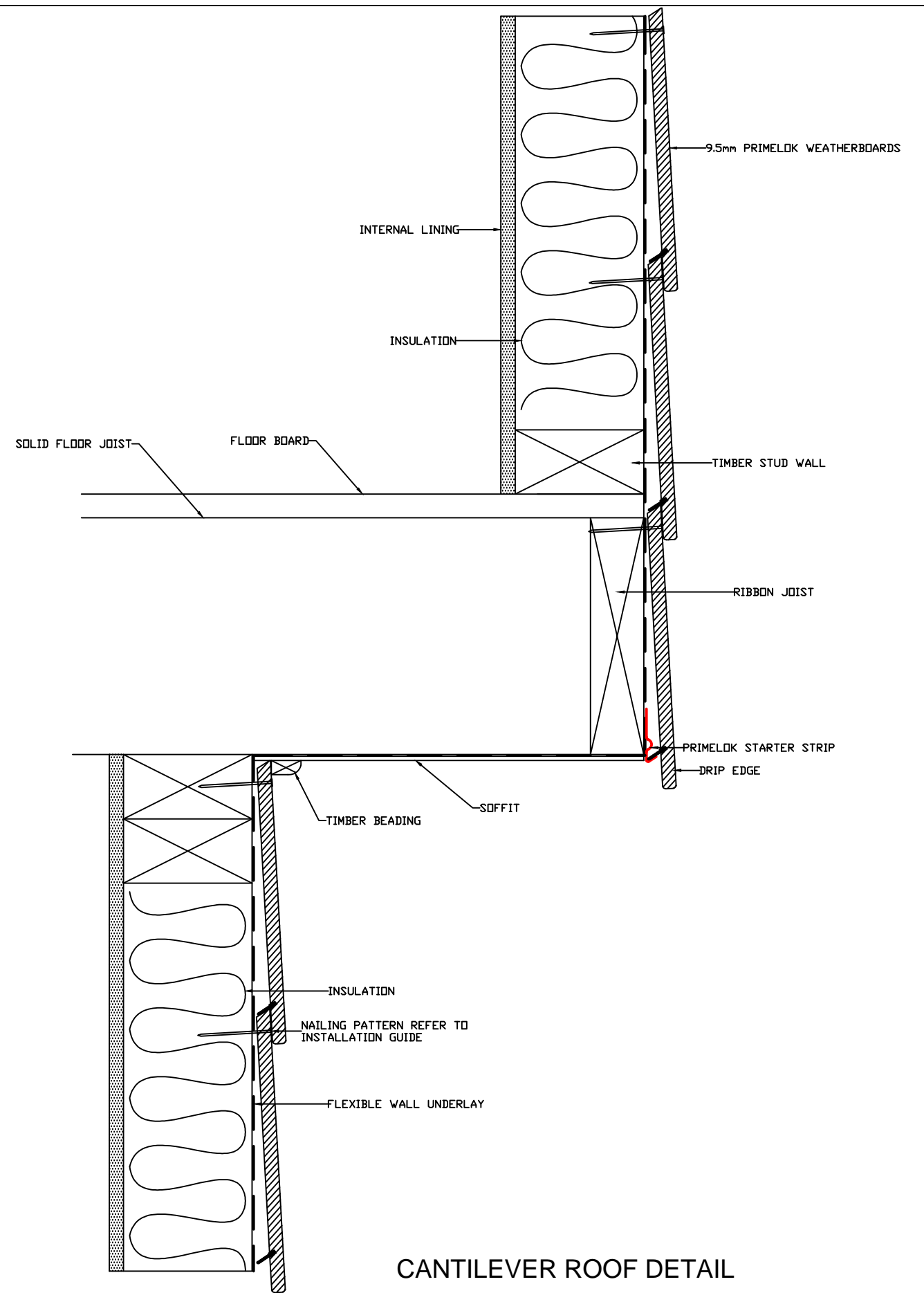

B



DRAWING NAME:

NZ DIRECT FIX INSTALLATION - PRIMELOK

SCALE:

NTS

DRAWN BY:

A.MOATE

CHECKED BY:

C.O'NEILL

DATE:

12.12.19

DRAWING No.:

CD-PL-C20-10

SHT SIZE

A3

